

## Trademarks

Autel®, MaxiSys®, MaxiDAS®, MaxiScan®, MaxiTPMS®, MaxiRecorder®, and MaxiCheck® are trademarks of Autel Intelligent Technology Corp., Ltd., registered in China, the United States and other countries. All other marks are trademarks or registered trademarks of their respective holders.

## Copyright Information

No part of this manual may be reproduced, stored in a retrieval system or transmitted, in any form or by any means, electronic, mechanical, photocopying, recording, or otherwise without the prior written permission of Autel.

## Disclaimer of Warranties and Limitation of Liabilities

All information, specifications and illustrations in this manual are based on the latest information available at the time of printing. Autel reserves the right to make changes at any time without notice. While information of this manual has been carefully checked for accuracy, no guarantee is given for the completeness and correctness of the contents, including but not limited to the product specifications, functions, and illustrations.

Autel will not be liable for any direct damages or for any special, incidental, or indirect damages or for any economic consequential damages (including the loss of profits).

---

### IMPORTANT

Before operating or maintaining this unit, please read this manual carefully, paying extra attention to the safety warnings and precautions.

---

## For Services and Support:



[pro.autel.com](http://pro.autel.com)  
[www.autel.com](http://www.autel.com)



1-855-288-3587/1-855-AUTELUS (North America)  
0086-755-86147779 (China)



[support@autel.com](mailto:support@autel.com)

For technical assistance in all other markets, please refer to *Technical Support* section in this manual.

# Safety Information

---

For your own safety and the safety of others, and to prevent damage to the device and vehicles upon which it is used, it is important that the safety instructions presented throughout this manual be read and understood by all persons operating or coming into contact with the device.

There are various procedures, techniques, tools, and parts for servicing vehicles, as well as in the skill of the person doing the work. Because of the vast number of test applications and variations in the products that can be tested with this equipment, we cannot possibly anticipate or provide advice or safety messages to cover every circumstance. It is the automotive technician's responsibility to be knowledgeable of the system being tested. It is crucial to use proper service methods and test procedures. It is essential to perform tests in an appropriate and acceptable manner that does not endanger your safety, the safety of others in the work area, the device being used, or the vehicle being tested.

Before using the device, always refer to and follow the safety messages and applicable test procedures provided by the manufacturer of the vehicle or equipment being tested. Use the device only as described in this manual. Read, understand, and follow all safety messages and instructions in this manual.

## Safety Messages

Safety messages are provided to help prevent personal injury and equipment damage. All safety messages are introduced by a signal word indicating the hazard level.

---

### **DANGER**

Indicates an imminently hazardous situation which, if not avoided, will result in death or serious injury to the operator or to bystanders.

---

### **WARNING**

Indicates a potentially hazardous situation which, if not avoided, could result in death or serious injury to the operator or to bystanders.

---

## Safety Instructions

---

The safety messages herein cover situations Autel is aware of. Autel cannot know, evaluate or advise you as to all of the possible hazards. You must be certain that any condition or service procedure encountered does not jeopardize your personal safety.

---

 **DANGER**

When an engine is operating, keep the service area WELL VENTILATED or attach a building exhaust removal system to the engine exhaust system. Engines produce carbon monoxide, an odorless, poisonous gas that causes slower reaction time and can lead to serious personal injury or loss of life.

---

 **Do Not Turn the Volume Up Too Loud When Using Headphones**

Listening at high volumes that over-stimulate the ear for long periods of time may result in loss of hearing.

 **SAFETY WARNINGS:**

- Always perform automotive testing in a safe environment.
- Wear safety eye protection that meets ANSI standards.
- Keep clothing, hair, hands, tools, test equipment, etc. away from all moving or hot engine parts.
- Operate the vehicle in a well-ventilated work area, for exhaust gases are poisonous.
- Put the transmission in PARK (for automatic transmission) or NEUTRAL (for manual transmission) and make sure the parking brake is engaged.
- Put blocks in front of the drive wheels and never leave the vehicle unattended while testing.
- Be extra cautious when working around the ignition coil, distributor cap, ignition wires and spark plugs. These components create hazardous voltages when the engine is running.
- Keep a fire extinguisher suitable for gasoline, chemical, and electrical fires nearby.
- Do not connect or disconnect any test equipment while the ignition is on or the engine is running.
- Keep the test equipment dry, clean, free from oil, water or grease. Use a mild detergent on a clean cloth to clean the outside of the equipment as necessary.
- Do not drive the vehicle and operate the test equipment at the same time. Any distraction may cause an accident.
- Refer to the service manual for the vehicle being serviced and adhere to all diagnostic procedures and precautions. Failure to do so may result in personal injury or damage to the test equipment.
- To avoid damaging the test equipment or generating false data, make sure the vehicle battery is fully charged and the connection to the vehicle DLC is clean and secure.
- Do not place the test equipment on the distributor of the vehicle. Strong electro-magnetic interference can damage the equipment.

# CONTENTS

1	USING THIS MANUAL .....	1
	CONVENTIONS .....	1
	<i>Bold Text</i> .....	1
	<i>Note</i> .....	1
	<i>Important</i> .....	1
	<i>Hyperlink</i> .....	1
	<i>Procedures</i> .....	1
2	GENERAL INTRODUCTION .....	3
	MAXISYS MS906CV DISPLAY TABLET .....	3
	<i>Functional Description</i> .....	3
	<i>Power Sources</i> .....	5
	<i>Technical Specifications</i> .....	5
	ACCESSORIES KIT .....	7
	<i>Main Cable</i> .....	7
	<i>OBD I Adapters</i> .....	7
	<i>Other Accessories</i> .....	8
3	GETTING STARTED .....	9
	POWERING UP .....	9
	<i>Application Buttons</i> .....	10
	<i>Locator and Navigation Buttons</i> .....	11
	<i>System Status Icons</i> .....	12
	POWERING DOWN.....	13
	<i>Reboot System</i> .....	14
	INSTALLING COMPUTER SOFTWARE .....	14
	<i>Printing Operation</i> .....	14
4	CV DIAGNOSTICS .....	16
	ESTABLISHING VEHICLE COMMUNICATION .....	16
	<i>Vehicle Connection</i> .....	16
	GETTING STARTED .....	17
	<i>Vehicle Menu Layout</i> .....	17
	VEHICLE IDENTIFICATION .....	19
	<i>Auto VIN Scan</i> .....	20

	<i>Manual VIN Input</i> .....	21
	<i>Automatic Selection</i> .....	22
	<i>Manual Selection</i> .....	22
	<i>System Selection</i> .....	23
	NAVIGATION .....	23
	<i>Diagnostics Screen Layout</i> .....	23
	<i>Screen Messages</i> .....	26
	<i>Making Selections</i> .....	26
	DIAGNOSIS .....	27
	<i>ECU Information</i> .....	30
	<i>Trouble Codes</i> .....	31
	<i>Live Data</i> .....	33
5	SERVICE .....	39
	OIL RESET SERVICE .....	40
	ELECTRONIC PARKING BRAKE (EPB) SERVICE .....	41
	<i>EPB Safety</i> .....	42
	STEERING ANGLE SENSOR (SAS) SERVICE .....	44
	<i>Calibrate ESC Steering Wheel Angle Sensor</i> .....	45
	DPF SERVICE .....	46
	<i>DPF Deep Clean Regeneration</i> .....	47
	CYLINDER SERVICE .....	48
	<i>Cylinder Cutout Test</i> .....	49
	TURBO SERVICE .....	51
	<i>VGT Electronic Actuator Installation and Calibration</i> .....	51
	INJECTOR SERVICE .....	53
	<i>High Pressure Common Rail Injector Setup</i> .....	54
6	SHOP MANAGER .....	56
	VEHICLE HISTORY .....	57
	<i>Historical Test Record</i> .....	58
	WORKSHOP INFORMATION .....	59
	CUSTOMER MANAGER .....	59
	<i>History Notes</i> .....	60
7	DATA MANAGER .....	63

OPERATIONS.....	63
<i>Image Files</i> .....	63
<i>PDF Files</i> .....	65
<i>Review Data</i> .....	66
<i>Apps Uninstall</i> .....	66
<i>Data Logging</i> .....	67
8 SETTINGS.....	68
UNIT.....	68
LANGUAGE.....	69
PRINTING SETTING.....	70
<i>Printing via APP</i> .....	70
<i>Printing via PC</i> .....	70
FIRMWARE.....	71
NOTIFICATION CENTER.....	72
MULTITASK.....	72
AUTO UPDATE.....	73
SYSTEM SETTINGS.....	74
ABOUT.....	75
9 UPDATE.....	77
10 FUNCTION VIEWER.....	79
11 SUPPORT.....	81
PRODUCT REGISTRATION.....	81
SUPPORT SCREEN LAYOUT.....	82
MY ACCOUNT.....	82
<i>Personal Info</i> .....	82
<i>Update Info</i> .....	83
<i>Service Info</i> .....	83
USER COMPLAINT.....	83
DATA LOGGING.....	85
COMMUNITIES.....	86
<i>User Profile</i> .....	87
TRAINING CHANNELS.....	87
FAQ DATABASE.....	88

12	ACADEMY .....	89
13	REMOTE DESK.....	90
14	QUICK LINK .....	92
15	MAXIFIX .....	93
	NAVIGATION .....	93
	<i>The Header</i> .....	94
	<i>Select Vehicle Button</i> .....	94
	<i>Terminology</i> .....	94
	OPERATIONS.....	96
	<i>Home</i> .....	96
	<i>Search Fix Features</i> .....	96
	<i>Ask</i> .....	97
	<i>My MaxiFix</i> .....	98
	<i>My Messages</i> .....	99
	<i>Support</i> .....	100
16	MAINTENANCE AND SERVICE .....	101
	MAINTENANCE INSTRUCTIONS .....	101
	TROUBLESHOOTING CHECKLIST .....	101
	ABOUT BATTERY USAGE .....	102
	SERVICE PROCEDURES .....	103
	<i>Technical Support</i> .....	103
	<i>Repair Service</i> .....	104
	<i>Other Services</i> .....	105
17	COMPLIANCE INFORMATION .....	106
18	WARRANTY .....	108
	12-MONTH LIMITED WARRANTY .....	108

# 1 Using This Manual

This manual contains device usage instructions.

Some illustrations shown in this manual may contain modules and optional equipment that are not included in your system. Contact your sales representative for availability of other modules and optional tools or accessories.

## Conventions

---

The following conventions are used.

### Bold Text

Bold text is used to highlight selectable items such as buttons and menu options.

Example:

- Tap **OK**.

### Note

A **NOTE** provides helpful information such as additional explanations, tips, and comments.

### Important

**IMPORTANT** indicates a situation which, if not avoided, may result in damage to the test equipment or vehicle.

### Hyperlink

Hyperlinks, or links, that take you to other related articles, procedures, and illustrations are available in electronic documents. Blue colored text indicates a selectable hyperlink.

### Procedures

An arrow icon indicates a procedure.

Example:



➤ **To use the camera:**

1. Tap the **Camera** button. The camera screen opens.
2. Focus the image to be captured in the view finder.
3. Tap the blue circle. The view finder now shows the captured picture and auto-saves the taken photo.

# 2 General Introduction

The MaxiSys® MS906CV is an advanced diagnostic device developed for customers looking for a tool with ultra-convenient and modern design while delivering ultimate performance. Featuring the powerful Samsung Exynos 5260 6-core processor (1.3 GHz quad-core ARM Cortex-A7 + 1.7 GHz dual-core ARM Cortex-A15), and an 8.0 inch LED capacitive touch screen, based on the Android multitasking operating system, and combined with the best possible coverage of OE-level diagnostics, the MaxiSys MS906CV is an ideal solution to manage your repair jobs smartly and conveniently with greater integration.

This manual describes the construction and operation of the device and how it works to deliver diagnostic solutions.

## MaxiSys MS906CV Display Tablet

---

### Functional Description

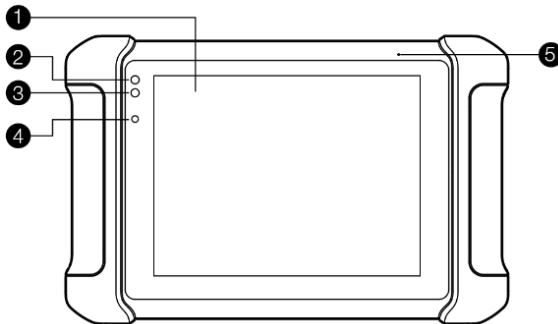

**Figure 2-1 MaxiSys MS906CV Tablet Front View**

1. 8.0" LED Capacitive Touch Screen
2. Power LED – indicates battery level & charging or system status.
3. Vehicle Communication LED – flashes green when the Display Tablet is communicating/linking with the vehicle's system.
4. Ambient Light Sensor – detects ambient brightness.
5. Microphone

The power LED displays different colors in response to the following scenarios:

A. Green:

- Illuminates green when the Display Tablet is charging and the battery level is above 90%.
- Illuminates green when the Display Tablet is powered on and the battery level is above 15%.

B. Yellow:

- Illuminates yellow when the Display Tablet is charging and the battery level is below 90%.

C. Red:

- Illuminates red when the Display Tablet is powered on and the battery level is below 15%.

D. Blue:

- Illuminates blue when the MaxiSys system is fault.

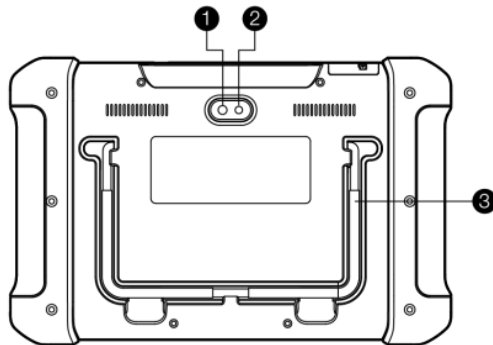

**Figure 2-2 MaxiSys MS906CV Tablet Back View**

1. Camera Lens
2. Camera Flash
3. Collapsible Stand – extends from the back to allow hands-free viewing of the Display Tablet at a 30-degree angle.

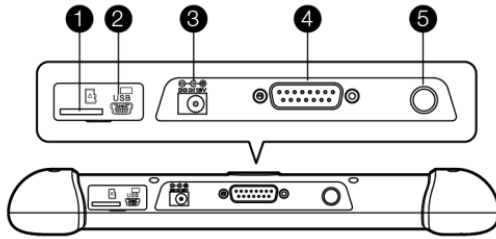

**Figure 2-3 MaxiSys MS906CV Tablet Top View**

1. Mini SD Card Slot – holds the mini SD Card.
2. Mini USB Port
3. DC Power Supply Input Port – connects the 12 volt power adapter to charge.
4. DB15-Pin Port – connects the vehicle DLC cable.
5. Lock/Power Button – turns the device on & off with long press, or locks the screen with short press.

## Power Sources

The Display Tablet can receive power from any of the following sources:

- Internal Battery Pack
- AC/DC Power Supply

### *Internal Battery Pack*

The Display Tablet can be powered with the internal rechargeable battery, which if fully charged can provide sufficient power for about 6 hours of continuous operation.

### *AC/DC Power Supply*

The Display Tablet can be powered from a wall socket using the AC/DC power adapter. The AC/DC power supply charges the internal battery pack.

## Technical Specifications

**Table 2-1 Technical Specifications**

Item	Description
Operating System	Android™ 4.4.2, KitKat

Item	Description
<b>Processor</b>	Samsung Exynos 6-Core Processor (1.3 GHz quad-core ARM Cortex-A7 + 1.7 GHz dual-core ARM Cortex-A15)
<b>Memory</b>	2 GB RAM & 32 GB ROM
<b>Display</b>	8.0 inch LED capacitive touch screen with 1024x768P resolution
<b>Connectivity</b>	<ul style="list-style-type: none"> <li>● Wi-Fi (802.11 b/g/n)</li> <li>● DB16 DLC</li> <li>● USB 2.0</li> <li>● SD Card (Support up to 32GB)</li> </ul>
<b>Camera (rear)</b>	Rear-facing, 8.0 Megapixel, AF with Flashlight
<b>Sensors</b>	Gravity Accelerometer, Ambient Light Sensor (ALS)
<b>Audio Input/Output</b>	<ul style="list-style-type: none"> <li>● Microphone</li> <li>● Single Speaker</li> </ul>
<b>Power and Battery</b>	<ul style="list-style-type: none"> <li>● 3.7V/5000 mAh lithium-polymer battery</li> <li>● Charging via 12 V AC/DC power supply</li> </ul>
<b>Input Voltage</b>	DC/12 V (9-35 V)
<b>Power Consumption</b>	5 W
<b>Operating Tempe.</b>	0 to 55°C (32 to 131°F)
<b>Storage Temp.</b>	-20 to 60°C (-4 to 140°F)
<b>Housing</b>	Strong plastic housing with protective rubber boot
<b>Dimensions (W x H x D)</b>	270.8 mm (10.0") x 176.0 mm (6.9") x 36.0mm (1.4")
<b>Weight</b>	NW: 0.93 kg (2.05 lb.)
<b>Protocols</b>	ISO 9142-2, ISO 14230-2, ISO 15765-4, K-Line, L-Line, Flashing Code, SAE-J1850 VPW, SAE-J1850 PWM, CAN ISO 11898, Highspeed, Middlespeed, Lowspeed and Singlewire CAN, GM UART, UART Echo Byte Protocol, Honda Diag-H Protocol, TP 2.0, TP 1.6, SAE J1939, SAE J1708, Fault-Tolerant CAN

# Accessories Kit

---

## Main Cable

The Display Tablet can be powered through the Main Cable when connected to an OBD II/EODB compliant vehicle. The Main Cable connects the Display Tablet to the vehicle's data link connector (DLC).

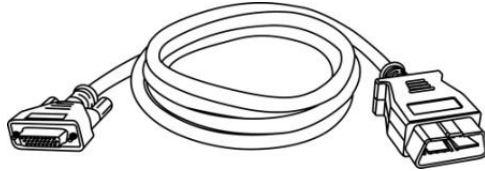
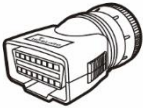

Figure 2-4 Main Cable – 1.7 m in length

## OBD I Adapters

The OBD I adapters are for Non-OBD II vehicles. The adapter used depends on the type of vehicle being tested. The most common adapters are shown below.



Deutsch-9

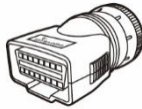

Deutsch-9



Unit-4



JW1 x2



JW2 x2



JW3 x2



JW4 x2



JW5 x2



JW6 x2



JW7 x2



JW8 x2



JW9 x2



JW10 x2

## Other Accessories



### USB Cable

Connects the Display Tablet to the PC.



### Mini USB Cable

Connects the Display Tablet to the PC.



### AC/DC Adapter (12V)

Connects the Display Tablet to the external DC power port for power supply.



### Cigarette Lighter

Provides power to the Display Tablet or the J2534 programming device through connection to the vehicle's cigarette lighter receptacle, as some non-OBD II vehicles cannot provide power via the DLC connection.



### Clipper Cable

Provides power to the Display Tablet or the J2534 programming device, through connection to the vehicle's battery.



### Light Fuse

A safety device for the cigarette lighter.

# 3 Getting Started

Make sure the Display Tablet has sufficient battery level or is connected to the DC power supply (see [Power Sources](#) on page 5).

## Powering Up

Press the Lock/Power button on the top right side of the Display Tablet to switch the unit on. The system boots up, and shows the lock screen. Pressing the inner ring with a Lock icon at the center displays 3 entry options:

1. **Unlock** – drags the inner ring to the right edge of the circle to enter the Android System’s Home Screen.
2. **MaxiSys** – drags the inner ring to the top edge of the circle to enter the MaxiSys Job Menu.
3. **Camera** – drags the inner ring to the left edge of the circle to launch the camera.

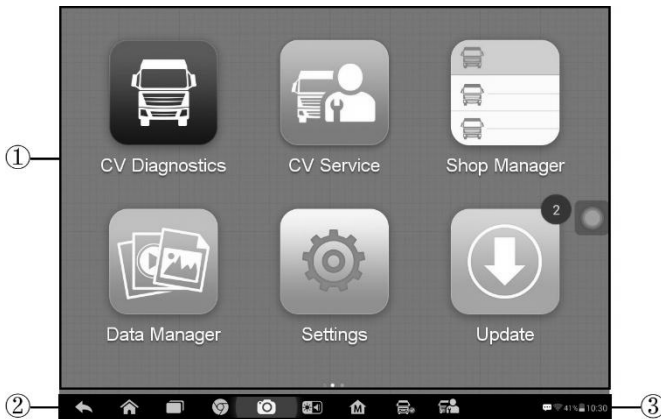

**Figure 3-1 Sample MaxiSys Job Menu**

1. Application Buttons
2. Locator and Navigation Buttons
3. Status Icons



 **NOTE**

The screen is locked by default when you first turn on the Display Tablet. It is recommended to lock the screen to protect the information in the system and reduce the power consumption.







Almost all operations on the Display Tablet are controlled through the touch screen. The touch screen navigation is menu driven, which allows you to quickly locate the test procedure, or data that you need, through a series of choices and questions. Detailed descriptions of the menu structures are found in the chapters for the various applications.







## Application Buttons

The Application buttons configure the MaxiSys for the type of operation or activity to be performed. The table below gives brief descriptions of the available applications.

Tap on the screen to select an application from the Job Menu.

**Table 3-1 Applications**



Button	Name	Description
	<b>CV Diagnostics</b>	Accesses the unit's diagnostics functions. See <a href="#">CV Diagnostics</a> on page 16.
	<b>CV Service</b>	Accesses special functions menu. See <a href="#">Service</a> on page 39 for details.
	<b>Shop Manager</b>	Allows you to edit and save workshop information and customer data, as well as reviewing test vehicle history records. See <a href="#">Shop Manager</a> on page 48.
	<b>Data Manager</b>	Opens the organization system for saved data files. See <a href="#">Data Manager</a> on page 63.
	<b>Settings</b>	Allows you to set the MaxiSys system settings, and to view the general information about the Display Tablet. See <a href="#">Settings</a> on page 68.
	<b>Update</b>	Checks for the latest update available for the MaxiSys system, and performs updating procedures. See <a href="#">Update</a> on page 77.







Button	Name	Description
	<b>Function Viewer</b>	Provides quick search for the supported functions and vehicles of Autel diagnostic tools. See <a href="#">Function Viewer</a> on page 79.
	<b>Support</b>	Launches the Support platform which synchronizes Autel's on-line service base station with the MaxiSys tablet. See <a href="#">Support</a> on page 81.
	<b>Academy</b>	Accesses technical tutorials and training articles about the device or vehicle diagnostic techniques. See <a href="#">Academy</a> on page 89 for details.
	<b>Remote Desk</b>	Configures your unit to receive remote support using the TeamViewer application program. See <a href="#">Remote Desk</a> on page 90.
	<b>Quick Link</b>	Provides associated website bookmarks to allow quick access to product update, service, support and other information. See <a href="#">Quick Link</a> on page 92.
	<b>MaxiFix</b>	Launches the MaxiFix platform which provides the most compatible and abundant repair techniques and diagnostics database. See <a href="#">MaxiFix</a> on page 93.

## Locator and Navigation Buttons

Operations of the Navigation buttons at the bottom of the screen are described in the table below:

**Table 3-2 Locator and Navigation Buttons**

Button	Name	Description
	<b>Locator</b>	Indicates the location of the screen. Swipe the screen left or right to view the previous or next screen.
	<b>Back</b>	Returns to the previous screen.

Button	Name	Description
	<b>Android Home</b>	Returns to Android System's Home screen.
	<b>Recent Apps</b>	Displays a list of applications that are currently working. To open an app, touch it. To remove an app, swipe it to the right.
	<b>Browser</b>	Launches the Android built-in browser.
	<b>Camera</b>	Opens the camera with short press; takes and saves screenshot image with long press. The saved files are auto-stored in the Data Manager application for later reviews. See <a href="#">Data Manager</a> on page 63.
	<b>Display &amp; Sound</b>	Allows you to adjust the brightness of the screen and the volume of the audio output.
	<b>MaxiSys Home</b>	Returns to MaxiSys Job Menu.
	<b>MaxiSys Shortcut</b>	Returns to the MaxiSys operation interface from other Android applications.

➤ **To use the camera:**

1. Tap the **Camera** button. The camera screen opens.
2. Focus the image to be captured in the view finder.
3. Tap the inner blue circle. The view finder now shows the captured picture and auto-saves the taken photo.
4. Tap the thumbnail image on the top right corner of the screen to view the stored image.
5. Tap the **Back** or **Home** button to exit the camera application.

Refer to Android documents for additional information.

## System Status Icons







As the Display Tablet is working with the Android operating system, you may refer to Android-related documents for more information.

By tapping on the bottom right corner, a Shortcuts Panel will be displayed, on which you are allowed to adjust various system settings of the tablet. Operations of each button on the panel are described in the table below:

 **NOTE**

The shortcuts buttons will be highlighted when enabled, and dimmed when disabled.

**Table 3-3 Shortcuts Panel Buttons**

Button	Name	Description
	<b>Calculator</b>	Launches calculator when pressed.
	<b>Clock</b>	Launches clock when pressed.
	<b>Wi-Fi</b>	Enables/disables Wi-Fi when pressed.
	<b>Torch</b>	Turns on/off the torch when pressed.
	<b>Auto Rotate</b>	Enables/disables auto-rotate screen when pressed.
	<b>Airplane Mode</b>	Enables/disables Airplane Mode when pressed.
	<b>System Settings</b>	Launches the Android System Settings interface when pressed.

## Powering Down

All vehicle communications must be terminated before shutting down the Display Tablet. A warning message displays if you attempt to shut down the Display Tablet when it is communicating with the vehicle. Forcing a shut-down while communicating may lead to ECM problems on some vehicles. Exit the Diagnostics application before powering down.

➤ **To power down the Display Tablet:**

1. Press and hold the Lock/Power Button.
2. Tap **Power off** option.
3. Tap **OK**; the tablet will turn off in a few seconds.

## Reboot System

In case of system crash, press and hold the Lock/Power button for 8 seconds to reboot the system.

## Installing Computer Software

---

The MaxiSys MS906CV Diagnostic Platform allows you to print the information needed for your convenience. To realize the printing function, you need to install the printer driver program.

➤ **To install the printer driver program**

1. Insert the CD into the CD-ROM of the computer and open the CD folder.
2. Double click on **Autel Run.exe** item.
3. Click the **MaxiSys Printer** icon in the MaxiSys PC Suite screen.
4. Select the installation language and the printer driver installation wizard will load momentarily.
5. Follow the wizard instructions on the screen and Click **Next** to continue.
6. Click on **Install** and the printer driver program will be installed onto the computer.
7. Click on **Finish** to complete the whole installation procedure.

---

 **NOTE**

The MaxiSys Printer runs automatically after the installation.

---

## Printing Operation

This section describes how to receive file from the Display Tablet and perform printing through the computer:

➤ **To perform printing through the computer**

1. Install the printer driver to the computer.
2. Before printing, make sure the Display Tablet is connected to the computer network, either via WiFi or LAN. See [Printing Setting](#) on page 70 for more information.
3. Run the MaxiSys Printer program on the computer to open up the printer interface.
4. Click **Test Print** to make sure the printer is working successfully.
5. Tap the **Print** button on the toolbar. A temporary file will be created and sent to the computer for printing.

6. The MaxiSys Printer will print the received document automatically when the **Auto Print** option is selected.

If you need to print the document later, click **Open PDF file** and select the document, and double click the **Print** button on the MaxiSys Printer interface to start the printing.

---

 **NOTE**

Make sure the computer installed with the Printing driver program is connected to a printer.

---

# 4 CV Diagnostics

By establishing a data link to the electronic control systems of the vehicle being serviced directly, the CV Diagnostics application allows you to retrieve diagnostic information, view live data parameters, and perform active tests. The CV Diagnostics application can access the electronic control module (ECM) for various vehicle control systems, such as engine, transmission, antilock brake system (ABS), airbag system (SRS) and more.

## Establishing Vehicle Communication

---

The Diagnostics operations require connecting the MaxiSys MS906CV diagnostic platform to the test vehicle using the main cable.

### Vehicle Connection

The method used to connect the Display Tablet to a vehicle's DLC depends on the vehicle's configuration as follows:

- A vehicle equipped with an On-board Diagnostics Two (OBD II) management system supplies both communication and 12-24 volt power through a standardized J-1962 DLC.
- A vehicle not equipped with an OBD II management system supplies communication through a DLC connection, and in some cases supplies 12-24 volt power through the cigarette lighter receptacle or a connection to the vehicle battery.

#### *OBD II Vehicle Connection*

This type of connection only requires the main cable without any additional adapter.

#### ➤ **To connect to an OBD II vehicle**

1. Connect the main cable's female adapter to the Vehicle Data Connector on the Display Tablet, and tighten the captive screws.
2. Connect the cable's 16-pin male adapter to the vehicle's DLC, which is generally located under the vehicle dash.

---

#### **NOTE**

The vehicle's DLC is not always located under the dash; refer to the user manual of the test vehicle for additional connection information.

---

## Non-OBD II Vehicle Connection

This type of connection requires both the main cable and a required OBD I adapter for the specific vehicle being serviced.

### ➤ **To connect to a Non-OBD II Vehicle**

1. Connect the main cable's female adapter to the Vehicle Data Connector on the Display Tablet, and tighten the captive screws.
2. Locate the required OBD I adapter and connect its 16-pin jack to the main cable's male adapter.
3. Connect the attached OBD I adapter to the vehicle's DLC.

---

### **NOTE**

Some adapters may have more than one adapter or may have test leads instead of an adapter. Whatever the case, make the proper connection to the vehicle's DLC as required.

---

Some DLC connections only supply communication and the power is to be supplied via the cigarette lighter connection.

### ➤ **To connect the cigarette lighter**

1. Plug the DC power connector of the cigarette lighter into the DC power supply input port on the Display Tablet.
2. Connect the male connector of the cigarette lighter into the vehicle's cigarette lighter receptacle.

---

## Getting Started

Prior to first use of the Diagnostics application, the Display Tablet must be properly connected to the vehicle's DLC.

### **Vehicle Menu Layout**

When the Display Tablet device is properly connected to the vehicle, the platform is ready to start vehicle diagnosis. Tap on the CV Diagnostics application button on the MaxiSys Job Menu, the screen then opens the Vehicle Men





**Figure 4-1 Sample Vehicle Menu Screen**





1. Top Toolbar Buttons
2. Manufacturer Buttons

*Top toolbar Buttons*

The operations of the Toolbar buttons at the top of the screen are listed and described in the table below:

**Table 4-1 Top Toolbar Buttons**

Button	Name	Description
	<b>Home</b>	Returns to the MaxiSys Job Menu.
	<b>VIN Scan</b>	Opens a dropdown list; tap <b>Auto Detect</b> for auto VIN detection; tap <b>Manual Input</b> to enter VIN manually.
	<b>All</b>	Displays all the vehicle makes in the vehicle menu.
	<b>History</b>	Displays the stored test vehicle history records. This option provides you direct access to the previously tested vehicle recorded during previous test sessions. See <a href="#">Vehicle History</a> on page 57.
	<b>Trucks</b>	Displays the truck makes in the vehicle menu.

Button	Name	Description
	<b>Buses</b>	Displays the bus makes in the vehicle menu.
	<b>Expert</b>	Displays the major automobile system manufacturers.
	<b>Search</b>	Opens the virtual keyboard, allowing you to manually enter the specific vehicle make required.
	<b>Cancel</b>	Exits the search screen, or cancels an operation.

### *Manufacturer Buttons*

The Manufacturer buttons display the various vehicle logos and the brand names. Select the required manufacturer button after establishing the communication with the test vehicle to start a diagnostic session.

Tapping the small envelop icon beside each vehicle brand name will open a PDF document displaying the function list of the diagnostic software, including the applicable models and functions.

---

#### **NOTE**

The Update icon displayed on the upper right of the vehicle brand name indicates there is available update for the vehicle. Tap this icon to enter the Update application directly.

---

## **Vehicle Identification**

---

The MaxiSys diagnostic system supports five methods for Vehicle Identification.

1. Auto VIN Scan
2. Manual VIN Input
3. Automatic Selection
4. Manual Selection
5. System Selection

# Auto VIN Scan

The MaxiSys diagnostic system features the latest VIN-based Auto VIN Scan function to identify vehicles and scan all the diagnosable ECUs and run diagnostics on the selected system. This function is compatible with 2006 and newer vehicles.

➤ **To perform Auto VIN Scan**

1. Tap the **Diagnostics** application button from the MaxiSys Job Menu. The Vehicle Menu displays.
2. Tap the **VIN Scan** button on the top toolbar to open a dropdown list.



**Figure 4-2 Sample Auto VIN Screen 1**

3. Select **Auto Detect**. Once the test vehicle is successfully identified, the screen will display the vehicle VIN. Tap **OK** at the bottom right to confirm the vehicle VIN. If the VIN does not match with the test vehicle's VIN, enter VIN manually or tap **Read** to acquire VIN again.



**Figure 4-3 Sample Auto VIN Screen 2**

4. Tap **Yes** to confirm the vehicle profile or **NO** if the information is not correct.



**Figure 4-4 Sample Vehicle Information Screen**

5. The tool establishes communication with the vehicle and reads the control unit information. Choose **Auto Scan** to scan all the test vehicle available systems or tap **Control Unit** to access a specific system to diagnose.

## Manual VIN Input

For vehicles that not supporting the Auto VIN Scan function, you may manually enter the vehicle VIN.

### ➤ To perform Manual VIN Input

1. Tap the **Diagnostics** application button from the MaxiSys Job Menu. The Vehicle Menu displays.
2. Tap the **VIN Scan** button on the top toolbar.
3. Select **Manual Input**.
4. Tap the input box and enter the correct VIN.



**Figure 4-5 Sample Manual VIN Screen**

5. Tap **Done**. Once the vehicle is identified, the Vehicle Diagnostics screen displays.
6. Tap **Cancel** to exit Manual Input.

## Automatic Selection

The Auto VIN Scan can be selected after selecting the test vehicle manufacturer.



**Figure 4-6 Sample Selection Screen**

### ➤ To perform Automatic Selection

1. Tap the **Diagnostics** application button from the MaxiSys Job Menu. The Vehicle Menu displays.
2. Tap the manufacturer button of the test vehicle.
3. Tap **Automatic Selection** and the VIN information will be automatically acquired. Follow the on-screen instruction to display the diagnostic screen.

## Manual Selection

When the vehicle's VIN is not automatically retrievable through the vehicle's ECU, or the specific VIN is unknown, the vehicle can be manually selected.

This mode of vehicle selection is menu driven, repeat the first two steps from the automatic selection operation and tap **Manual Selection**. Through a series of on-screen prompts and selections, the test vehicle is chosen. If needed, press the **Back** button at the bottom right corner of the screen to return to the previous screen.

# System Selection

This mode of vehicle selection allow you to select vehicle by the system and is also menu driven, repeat the first two steps from the automatic selection operation and tap **System Selection**. Through a series of on-screen prompts and selections, the test vehicle is chosen. If needed, press the **Back** button at the bottom right corner of the screen to return to the previous screen.

# Navigation

---

This section describes how to navigate the Diagnostics interface and select test options.

## Diagnostics Screen Layout

The diagnostic screens typically include four sections.









**Figure 4-7 Sample Diagnostics Screen**

1. Diagnostics Toolbar
2. Status Information Bar
3. Main Section
4. Functional Buttons

### *Diagnostics Toolbar*

The Diagnostics Toolbar contains a number of buttons that allow you to print or save the displayed data and make other controls. The table below provides a brief description for the operations of the Diagnostics Toolbar buttons:

**Table 4-2 Diagnostics Toolbar Buttons**

Button	Name	Description
	<b>Home</b>	Returns to the MaxiSys Job Menu.
	<b>Vehicle Swap</b>	Touching this button allows you to exit the diagnostic session of the currently identified test vehicle, and returns you to the vehicle menu screen to select another vehicle for testing.
	<b>Settings</b>	Opens the setting screen. See <a href="#">Settings</a> on page 68.
	<b>Print</b>	Saves and prints a copy of the displayed data. See <a href="#">Printing Setting</a> for additional information on page 70.
	<b>Help</b>	Provides instructions or tips for operations of various diagnostic functions.
	<b>Save</b>	<p>Tapping this button opens a submenu, on which there are 3 options available to save the displayed data.</p> <ul style="list-style-type: none"> <li>● Tap <b>Save This Page</b> to take a screenshot image</li> <li>● Tap <b>Save All Data</b> to save a PDF file (mostly used to save data that cover more than 1 page)</li> <li>● Tap <b>Start Saving</b> to record a video clip (only available for recording Live Data or special graph data)</li> </ul> <p>All saved data are stored in the Data Manager application for later reviews. See <a href="#">Data Manager</a> on page 63.</p>
	<b>Data Logging</b>	<p>Records the communication data and ECU information of the test vehicle. The saved data can be reported and sent to the technical center via the internet.</p> <p>You can go to the Support application to follow up the processing progress, see <a href="#">Data Logging</a> on page 85 for detailed information.</p>

Button	Name	Description
	<b>Send</b>	Tapping this button submits the Data Logging report to the technical center via the internet.

➤ **To print data in Diagnostics**

1. Tap the **Diagnostics** application button from the MaxiSys Job Menu. The **Print** button on the diagnostic toolbar is available throughout the whole Diagnostics operations.
2. Tap **Print** whenever you want to make a printing. A drop-down menu appears.
  - a) **Print This Page** – prints a screenshot copy of the current screen
  - b) **Print All Page** – prints a PDF copy of all displayed data
3. A temporary file will be created and send to the computer for printing.
4. When the file is transferred successfully, a confirmation message displays.

🔗 **NOTE**

Make sure the Display Tablet is connected to the computer network, either via Wi-Fi or LAN, before printing. For more instructions on printing, see [Printing Operation](#) on page 70 for details.

➤ **To submit Data Logging reports in Diagnostics**

1. Tap the **Diagnostics** application button from the MaxiSys Job Menu. The **Data Logging** button on the Diagnostic Toolbar is available throughout the whole Diagnostics operations.
2. Tap the **Data Logging** button. The button displays blue during the active recording process.
3. Tap the **Data Logging** button again to finish recording. A submission form will display to let you fill in the report information.
4. Tap the **Send** button to submit the report form via the internet, a confirmation message displays when sending is successful.

*Status Information Bar*

The Status Information Bar at the top of the Main Section displays the following items:

1. **Menu Title** – indicates the menu subject of the Main Section.
2. **Battery Icon** – indicates the battery status of the vehicle.



## *Main Section*

The Main Section of the screen varies depending on the stage of operations. The Main Section can show vehicle identification selections, the main menu, test data, messages, instructions and other diagnostic information.

## *Functional Buttons*

The displayed Functional Buttons at this section of the screen varies depending on the stage of operations. They can be used to navigate, save or clear the diagnostic data, exit scanning as well as make other functional controls. The functions of these buttons will be introduced respectively in the following sections of the corresponding test operations.

## **Screen Messages**

Screen messages appear when additional input is needed before proceeding. There are mainly three types of on-screen messages as to their purposes: Confirmation, Warning, and Error.

### *Confirmation Messages*

This type of messages usually displays as an “Information” screen, which informs you when you are about to perform an action that cannot be reversed or when an action has been initiated and your confirmation is needed to continue.

When a user-response is not required to continue, the message displays briefly before automatically disappearing.

### *Warning Messages*

This type of messages informs you when completing the selected action may result in an irreversible change or loss of data. The typical example for this is the “Erase Codes” message.

### *Error Messages*

Error messages inform you when a system or procedural error has occurred. Examples of possible errors include a disconnected cable or communication interruption due to certain reasons.

## **Making Selections**

The Diagnostics application is a menu driven program that presents a series of choices one at a time. As you select from a menu, the next menu in the series displays. Each

selection narrows the focus and leads to the desired test. Use your fingertip or the stylus pen to make menu selections.

## Diagnosis

There are two options available when accessing the Diagnosis section:

1. **Auto scan** – starts auto scanning for all the available systems on the vehicle.
2. **Control unit** – displays a selection menu of all available control units of the test vehicle.

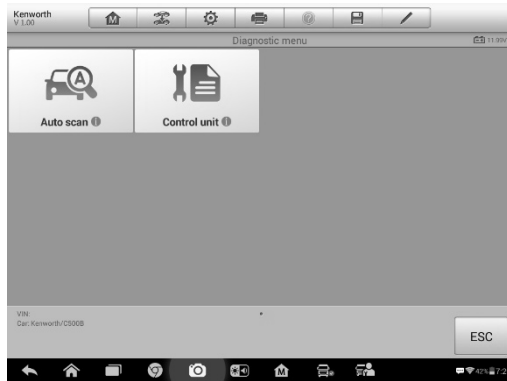

Figure 4-8 Sample Diagnosis Screen

### Auto Scan

[The Auto Scan function performs a comprehensive scanning over all the systems on the vehicle's ECU in order to locate fault systems and retrieve DTCs. The sample operation interface of Auto Scan displays as below:]

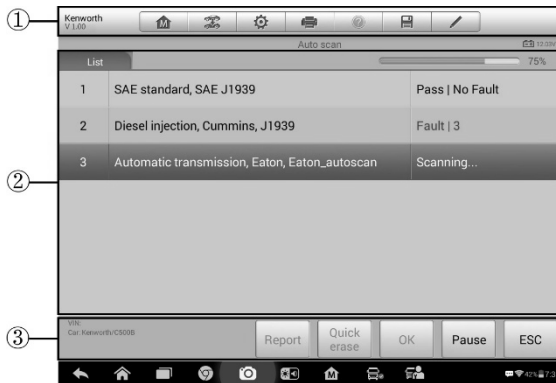

Figure 4-9 Sample Auto Scan Operation Screen

1. Navigation Bar
2. Main Section
3. Functional Buttons

- **Navigation Bar**

1. List Tab – displays the scanned data in list format.
2. Tree Tab – displays the scanned data in system distribution diagram format.
3. Progress Bar – indicates the test progress.

- **Main Section**

- A. *List Tab*

Column 1 – displays the system numbers.

Column 2 – displays the scanned systems.

Column 3 – displays the diagnostic marks indicating different conditions of the test result:

**-!-**: Indicates that the scanned system may not support the code reading function, or there is a communication error between the tester and the control system.

**-?-**: Indicates that the vehicle control system has been detected, but the tester cannot accurately locate it.

**Fault | #**: Indicates there is/are detected fault code(s) present; “#” indicates the number of the detected faults.

**Pass | No Fault**: Indicates the system has passed the scanning process and no fault has been detected.

- B. *Tree Tab*

The tree tab screen displays a system distribution diagram of the vehicle control modules. The scanned system which has passed scanning with no fault is shown in blue font; whereas the scanned system that has been detected with fault present is shown in red font.

- Tap the  button to the right of the system item, on which you want to perform further diagnosis and other test activities. A Function Menu screen shall then display.

- **Functional Buttons**

The table below provides a brief description of the Functional Buttons’ operations in Auto Scan:

**Table 4-3 Functional Buttons in Auto Scan**

Name	Description
<b>Back</b>	Returns to the previous screen or exit Auto Scan.
<b>Pause</b>	Suspends scanning and changes to show the <b>Continue</b> button.
<b>OK</b>	Confirms the test result, and continues to the system diagnosis after selecting the required system by tapping the item in the Main Section.
<b>Quick Erase</b>	Deletes codes. A warning message screen will display to inform you of possible data loss when this function is selected.
<b>Report</b>	Displays the diagnostic data in the report form.
<b>Save</b>	Saves the diagnostic session as a history record, this allows you to quickly restore access to the test systems.

### *Control Units*

This option allows you to manually locate a required control system for testing through a series of choices. You simply follow the menu driven procedure, and make proper selection each time; the program will guide you to the diagnostic function menu after a few choices you've made.

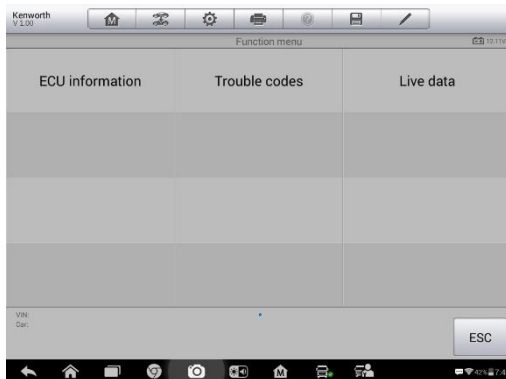

**Figure 4-10 Sample Function Menu Screen**

The Function Menu options vary slightly for different vehicles. The function menu may include:

- **ECU Information** – provides the retrieved ECU information in detail. Selecting opens an information screen.
- **Trouble Codes** – displays detailed information of DTC records retrieved from the vehicle control module and erases DTC records and other data from the ECM.
- **Live Data** – retrieves and displays live data and parameters from the vehicle's ECU.

**NOTE**

With the diagnostic toolbar on top of the screen throughout the whole diagnostic procedures, you are allowed to make various controls of the diagnostic information at any time, such as printing and saving the displayed data, getting help information, or performing data logging, etc.

➤ **To perform a diagnostic function**

1. Establish communication with the test vehicle.
2. Identify the test vehicle by selecting from the menu options.
3. Select the **Diagnosis** section.
4. Locate the required system for testing by **Auto Scan** or through menu driven selections in **Control Units**.
5. Select the desired test from the **Function Menu**.

## ECU Information

This function retrieves and displays the specific information for the tested control unit, including unit type, version numbers and other specifications. The sample ECU Information screen displays as below:

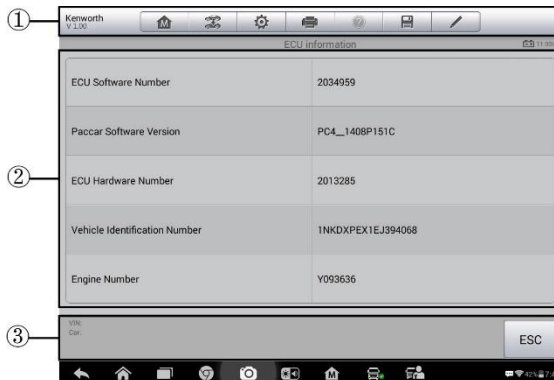
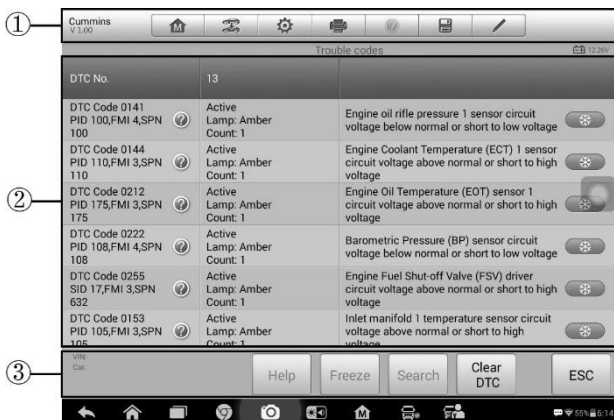

**Figure 4-11 Sample ECU Information Screen**

1. **Diagnostics Toolbar Buttons** – see [Table 4-2 Diagnostics Toolbar Buttons](#) on page 24 for detailed descriptions of the operations for each button.
2. **Main Section** – the left column displays the item names; the right column shows the specifications or descriptions.
3. **Functional Button** – in this case, only a **Back** (or sometimes an ESC) button is available; tap it to exit after viewing.

## Trouble Codes

This function retrieves, displays and erase the DTCs from the vehicle's control system. The Trouble Codes screen varies for each vehicle being tested. When the Freeze Frame data of certain DTCs are available for viewing, a snowflake button will display on the right side of the DTC item. For some vehicles, the Trouble Codes function will display as three functions separately, Read DTC, Clear DTC, and Freeze Frame.



**Figure 4-12 Sample Trouble Codes Screen**

1. **Diagnostics Toolbar Buttons** – see [Table 4-2 Diagnostics Toolbar Buttons](#) on page 24 for detailed descriptions of the operations for each button.
2. **Main Section**
  - Code Column – displays the retrieved codes from the vehicle.
  - Status Column – indicates the status of the retrieved codes.
  - Description Column – detailed descriptions for the retrieved codes.
  - Snowflake Icon – only displays when freeze frame data is available for viewing; Selecting this icon will display a data screen, which looks very similar to the Read Codes interface, therefore same operation method may be applied.
3. **Functional Button**
  - Help – displays the detailed codes-related information.

- Freeze Frame – displays the critical parameter values at the time the DTC is set.
- Search – searches for the codes-related information online. Internet connection is required for this function.
- Clear DTC – erases the trouble codes.
- ESC – returns to the previous screen or exit the current functions.

- **Stored Codes**

Stored codes are the current emission related DTCs from the ECM of the vehicle. OBD II/EOBD Codes have a priority according to their emission severity, with higher priority codes overwriting lower priority codes. The priority of the code determines the illumination of the MIL and the codes erase procedure. Manufacturers rank codes differently, so expect to see differences between makes.

- **Pending Codes**

These are codes whose setting conditions were met during the last drive cycle, but need to be met on two or more consecutive drive cycles before the DTC actually sets. The intended use of this service is to assist the service technician after a vehicle repair and after clearing diagnostic information, by reporting test results after a driving cycle.

- a) If a test failed during the driving cycle, the DTC associated with that test is reported. If the pending fault does not occur again within 40 to 80 warm-up cycles, the fault is automatically cleared from memory.
- b) Test results reported by this service do not necessarily indicate a faulty component or system. If test results indicate another failure after additional driving, then a DTC is set to indicate a faulty component or system, and the MIL is illuminated.

- **Freeze Frame**

In most cases the stored frame is the last DTC that occurred. Certain DTCs, which have a greater impact on vehicle emission, have a higher priority. In these cases, the top prioritized DTC is the one for which the freeze frame records are retained. Freeze frame data includes a “snapshot” of critical parameter values at the time the DTC is set.

- **Clear DTC**

This option is used to clear all emission related diagnostic data such as, DTCs, freeze frame data and manufacturer specific enhanced data from the vehicle’s ECM.

A confirmation screen displays when the clear codes option is selected to prevent accidental loss of data. Select **Yes** on the confirmation screen to continue or **No** to exit.

# Live Data

When this function is selected, the screen displays the data list for the selected module. The items available for any control module vary from one vehicle to another. The parameters display in the order that they are transmitted by the ECM, so expect variation between vehicles.

Gesture scrolling allows you to quickly move through the data list. Simply swipe the screen up or down to locate the data you want. The figure below shows a typical Live Data screen:

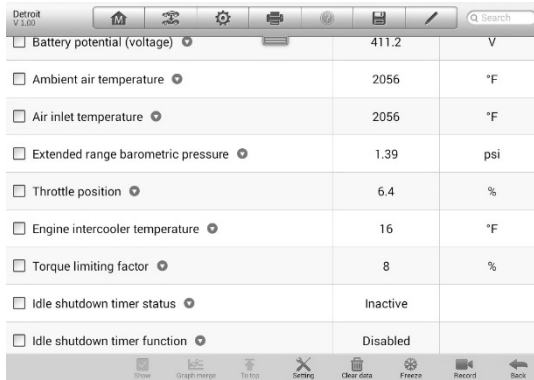

Parameter Name	Value	Unit
<input type="checkbox"/> Battery potential (voltage)	411.2	V
<input type="checkbox"/> Ambient air temperature	2056	*F
<input type="checkbox"/> Air inlet temperature	2056	*F
<input type="checkbox"/> Extended range barometric pressure	1.39	psi
<input type="checkbox"/> Throttle position	6.4	%
<input type="checkbox"/> Engine intercooler temperature	16	*F
<input type="checkbox"/> Torque limiting factor	8	%
<input type="checkbox"/> Idle shutdown timer status	Inactive	
<input type="checkbox"/> Idle shutdown timer function	Disabled	

**Figure 4-13 Sample Live Data Screen**

- Diagnostics Toolbar Buttons** – taps the drop-down button at the top center of the screen and the toolbar buttons will display. See [Table 4-2 Diagnostics Toolbar Buttons](#) on page 24 for detailed descriptions of the operations for each button.
- Main Section**
  - Name Column – this column displays the parameter names.
    - Check Box** – taps the check box at the left side of the parameter name to make selection of an item. Tap the check box again to deselect the item.
    - Drop-down Button** – tapping the drop-down button at the right side of the parameter name opens a submenu, which provides various choices for data display mode.
      - Value Column – displays the values of the parameter items.
      - Range Column – displays the minimum and the maximum value.
      - Unit Column – displays the unit for the parameters.
  - To change the unit mode, tap the **Setting** button on the top toolbar and select a required mode. See [Settings](#) on page 68 for more information.
- Display Mode**



There are 4 types of display modes available for data viewing, allowing you to view various types of parameters in the most suitable way.

Tapping the drop-down button on the right side of the parameter name opens a submenu. There are 4 buttons to configure the data display mode, and one Help button on the right that you can tap for additional information.

Each parameter item displays the selected mode independently.

**Analog Gauge Mode** – displays the parameters in form of an analog meter graph

**Text Mode** – this is the default mode which displays the parameters in texts and shows in list format

---

 **NOTE**

Reading of status parameters, such as a switch reading, which are mostly in word form, like ON, OFF, ACTIVE, and ABORT, etc., can only be displayed in Text Mode. Whereas reading of value parameters, such as a sensor reading, can be displayed in text mode and other graph modes.

---

**Waveform Graph Mode** – displays the parameters in waveform graphs

When this mode is applied, three control buttons will appear on the right side of the parameter item, allowing you to manipulate the display status.

- **Text Button** – resumes Text Display Mode
- **Scale Button** – changes the scale values, which are displayed below the waveform graph. There are 4 scales available: x1, x2, x4 and x8.
- **Zoom-in Button** – taps once to display the selected data graph in full screen

**Digital Gauge Mode** – displays the parameters in form of a digital gauge graph

**Full Screen Display** – this option is only available in the waveform graph mode, and mostly used in Graph Merge status for data comparison. There are three control buttons available on the top right side of the screen under this mode.

- **Edit Button** – tapping this button opens an edit window, on which you can set the waveform color and the line thickness displayed for the selected parameter item.
  - **Scale Button** – changes the scale values, which are displayed below the waveform graph. There are 4 scales available: x1, x2, x4 and x8.
  - **Zoom-out Button** – exits full screen display.
- **To edit the waveform color and line thickness in a data graph**
1. Select 1 to 3 parameter items to display in Waveform Graph mode.
  2. Tap the **Zoom-in Button** on the right to display the data graph in full

screen.

3. Tap the **Edit Button**, and an edit window appears.
4. Select a parameter item on the left column.
5. Select a desired sample color from the second column.
6. Select a desired sample line thickness from the right column.
7. Repeat step 4-7 to edit the waveform for each parameter item.
8. Tap **Done** to save the setting and exit, or tap **Cancel** to exit without saving.

#### 4. **Functional Buttons**

The operations of all the available functional buttons on Live Data screen are described below:

**Back** – returns you to the previous screen or exit the function.

**Record** – starts recording the retrieved live data; the recorded data is then stored as a video clip in the Data Manager application for future reviews. This function could be triggered automatically at preset threshold value or manually as you choose, and the triggering mode and record duration can be configured in the Setting mode of Live Data.

**Freeze** – displays the retrieved data in freeze mode.

- Previous Frame – moves to the previous frame in the freeze data.
- Next Frame – moves to the next frame in the freeze data.

**Resume** – this button appears when the Record or Freeze function is applied. Tapping this button stops data recording, or exit freeze data mode, and resumes normal data display mode.

**Flag** – this button appears when the Record function is applied. Tapping this button sets flags for the recorded data at points wherever you choose. When playing back the recorded video clip later in *Data Manager*, the preset flag will enable a popup to allow input of text to take notes.

**Clear Data** – clears all previously retrieved parameter values at a cutting point whenever you choose.

**To Top** – moves a selected data item to the top of the list.

**Graph Merge** – taps this button to merge selected data graphs (for Waveform Graph Mode only). This function is very useful when making comparison between different parameters.

**NOTE**

This mode supports Graph Merge for 2 to 3 parameter items only, so select no less than 2 or no more than 3 items each time when making graph merge.

- To cancel Graph Merge mode, tap the drop-down button on the right side of the parameter name, and select a data display mode.

**Show Selected/Show All** – taps this option to switch between the two options; one displays the selected parameter items, the other displays all the available items.

**Setting** – tapping this button opens a setting screen, which allows you to set the trigger mode, recording duration, and various threshold values for data recording, and make other controls.

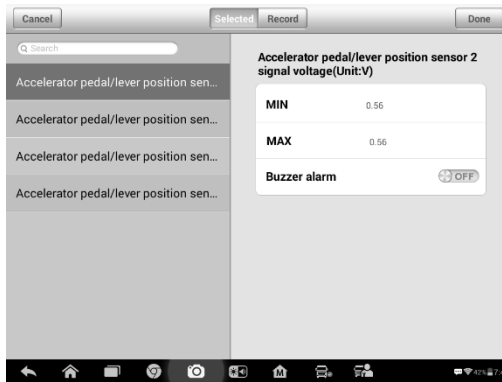



**Figure 4-14 Sample Setting Mode in Live Data**

There are four navigation buttons on top of the **Setting** mode screen.

- **Range Button** – displays the configuration screen on which you can set the threshold values, an upper limit and a lower limit, for triggering the buzzer alarm. This function is only applied to the Waveform Graph display mode.
  - a) **MIN** – tapping which opens a virtual keyboard, allowing you to enter the required lower limit value.
  - b) **MAX** – tapping which opens a virtual keyboard, allowing you to enter the required upper limit value.
  - c) **Buzzer Alarm** – switches the alarm on and off. The alarm function makes a beep sound as a reminder whenever the data reading reaches the preset minimum or maximum point.
- **To set threshold limits for the parameter values**
  1. Tap the **Setting** functional button at the bottom of the Live Data screen.

2. Tap the **Range** navigation button.
3. Select a parameter item on the left column, or enter the item name in the Search bar.
4. Tap on the right side of the **MIN** button, and enter the required minimum value.
5. Tap on the right side of the **MAX** button, and enter the required maximum value.
6. Tap the **ON/OFF** button on the right side of the Buzzer Alarm button to turn it on or off.
7. Tap **Done** to save the setting and return to the Live Data screen; or tap **Cancel** to exit without saving.

If the threshold limits are successfully set, two horizontal lines will appear on each of the data graphs (when Waveform Graph Mode is applied) to indicate the alarming point. The threshold lines are shown in different colors from the waveform of the parameters for distinction.

- **Record Button** – displays the configuration screen for Record Setting, on which you can set the trigger type, duration and trigger point for the data recording function.
  - a) **Trigger Type** – sets the trigger mode for data recording, mainly of two kinds: Manual and Auto. There are four options available:
    - 1) **Manual** – allows you to manually start and stop data recording.
    - 2) **DTC** – auto triggers data recording when any DTC is detected.
    - 3) **DTC Check Mode** – auto triggers data recording when certain pre-selected DTC types are detected.
    - 4) **Parameter** – auto triggers data recording when any parameter value reaches the preset threshold.
  - b) **Duration** – sets the recording time (for Auto trigger mode only)
  - c) **Trigger Point** – reserves a relative percentage of a record length before the data recording start point for reference (for Auto trigger mode only).
- **To perform setting for live data record**
  1. Tap the **Setting** functional button at the bottom of the Live Data screen.
  2. Tap the **Record** navigation button.
  3. Tap the  button on the right of **Trigger Type** bar and select the required trigger mode.
  4. Tap the  button on the right of **Duration** bar and select a length of time.

5. Tap the  button on the right of **Trigger Point** bar and select a relative percentage of a record length to be reserved before the data recording start point.
6. Tap **Done** to save the setting and return to the Live Data screen; or tap **Cancel** to cancel without saving and exit Setting.
  - **Done Button** – confirms and saves the setting, and returns you to the Live Data screen.
  - **Cancel Button** – cancels the setting operation, and returns you to the Live Data screen.

# 5 Service

The Service section is specially designed to provide you with quick access to the vehicle systems for various scheduled service and maintenance performances. The typical service operation screen is a series of menu driven executive commands. By following the on-screen instructions to select appropriate execution options, enter correct values or data, and perform necessary actions, the system will guide you through the complete performance for various service operations.

The most commonly performed service functions include:

- Oil Reset Service
- EPB Service
- SAS Service
- DPF Service
- Injector Service
- Turbo Service
- Cylinder Service



**Figure 5-1 Sample Service Function Screen**

After entering each special function, the displayed screen consists of two applications: **Diagnosis/Trouble codes** and **Hot Function/Special function**. The **Diagnosis/Trouble codes** is for you to read/clear data since this is necessary before and/or after some special functions. **Hot Functions/Special function** consists of sub functions of the selected special function. Sometimes, it is listed as **Active Test** instead of **Hot Functions/Special function** depending on the

# Oil Reset Service

---

This function allows you to perform reset for the Engine Oil Life system, which calculates an optimal oil life change interval depending on the vehicle driving conditions and climate. The Oil Life Reminder must be reset every time the oil is changed, so the system can calculate when the next oil change is required.

---

## **IMPORTANT**

Always reset the engine oil life to 100% after every oil change.

---

## **NOTE**

All required work must be carried out before the service indicators are reset. Failure to do so may result in incorrect service values and cause DTCs to be stored by the relevant control module.

---

## **NOTE**

For some vehicles, the scan tool can perform added functionality to reset additional service lights (maintenance cycle, service interval). Taking BMW as an example, its service reset function includes engine oil, spark plugs, front/rear brakes, coolant, particle filter, brake fluid, micro filter, vehicle inspection, exhaust emission inspection and vehicle check.

---

All software screens shown in this manual are examples, actual test screens may vary for each vehicle being tested. Observe the menu titles and on-screen instructions to make correct option selections.

### ➤ **To perform oil reset functions**

1. Tap the **Service** application button from the MaxiSys Job Menu.
2. Tap **Oil Reset** button and wait for the vehicle manufacturer screen. You can tap **VIN Scan** or the vehicle make to acquire vehicle VIN information and tap **Yes** to confirm. See [Vehicle Identification](#) on page 19 for detail.
3. **Trouble codes** function allows you to read and clear trouble codes before or after the service. Tap **Special functions** to display Oil Reset sub-function list, the list may vary for different vehicles being tested.
4. Tap the sub-function you want to carry out.



**Figure 5-2 Sample Oil Reset Function List**

5. Follow the step-by-step on-screen instruction to complete the service. Take **After treatment Maintenance** as an example, it allows the technician to install and reset the after treatment system.
6. Tap **After treatment Maintenance** on the Oil Reset function list to start the operation.
7. Tap the **Reset** button on the bottom of the screen to reset all the items or tap **Select reset option** to reset certain items. Tap **Refresh** button to refresh all the data.

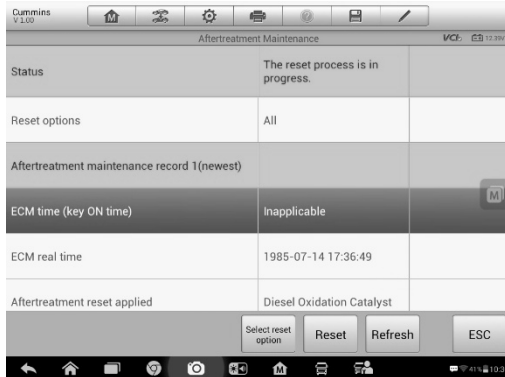

**Figure 5-3 Sample Oil Reset Service Screen 1**

8. When the reset is done, the availability would display as 100%. Tap **ESC** to exit.

## **Electronic Parking Brake (EPB) Service**

---

This function has a multitude of usages to maintain the electronic braking system safely and effectively. The applications include park brake cable replacement procedure, park



brake cable service apply, park brake cable service release, park brake calibration, parking brake cable apply, parking brake cable release, parking brake cable replacement, parking brake shoe service reset, parking brake switch procedure, park brake reset, brake pressure sensor calibration. The sub-function list may vary by test vehicle.

## EPB Safety

It may be dangerous to perform Electronic Parking Brake (EPB) system maintenance, so before you begin the service work, please keep these rules in mind.

- ✓ Ensure that you are fully familiar with the braking system and its operation before commencing any work.
- ✓ The EPB control system may be required to be deactivated before carrying out any maintenance/diagnostic work on the brake system. This can be done from the tool menu.
- ✓ Only carry out maintenance work when the vehicle is stationary and on level ground.
- ✓ Ensure that the EPB control system is reactivated after the maintenance work has been completed.

---

### NOTE

Autel accepts no responsibility for any accident or injury arising from the maintenance of the Electronic Parking Brake system.

---

#### ➤ **To perform EPB functions**

1. Tap the **Service** application button from the MaxiSys Job Menu.
2. Tap **EPB** button and wait for the vehicle manufacturer screen. You can tap **VIN Scan** or the vehicle make to acquire vehicle VIN information and tap **Yes** to confirm. See [Vehicle Identification](#) on page 19 for detail.
3. Tap the service you want in the EPB function list, the list may vary for different vehicles being tested.

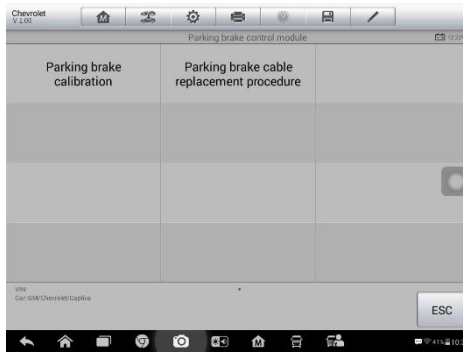

**Figure 5-4 Sample EPB Function List**

4. Follow the step-by-step on-screen instruction to complete the service. Take **Parking brake cable replacement procedure** as an example.

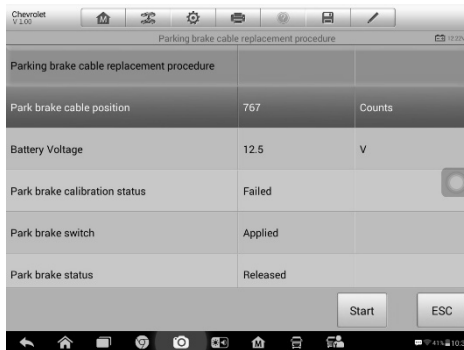

**Figure 5-5 Sample EPB Service Screen 1**

5. Tap **Start** to carry out the service and the park brake cable position will change. Once the service is completed, the technician can replace the park brake cable.

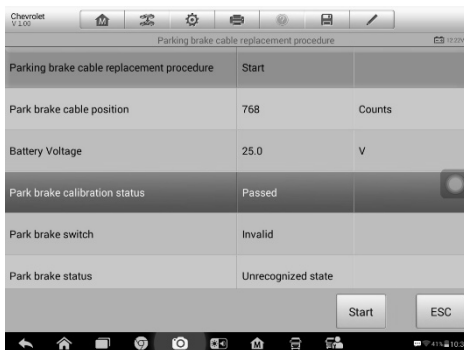

**Figure 5-6 Sample EPB Service Screen 2**

6. The park brake calibration status will display passed. Press **ESC** button to exit.

## **Steering Angle Sensor (SAS) Service**

---

Steering Angle Sensor Calibration permanently stores the current steering wheel position as the straight-ahead position in the steering angle sensor EEPROM. Therefore, the front wheels and the steering wheel must be set exactly to the straight-ahead position before calibration. In addition, the vehicle identification number is also read from the instrument cluster and stored permanently in the steering angle sensor EEPROM. On successful completion of calibration, the steering angle sensor fault memory is automatically cleared.

Calibration must always be carried out after the following operations:

- Steering wheel replacement
- Steering angle sensor replacement
- Any maintenance that involves opening the connector hub from the steering angle sensor to the column
- Any maintenance or repair work on the steering linkage, steering gear or other related mechanism
- Wheel alignment or wheel track adjustment
- Accident repairs where damage to the steering angle sensor or assembly, or any part of the steering system may have occurred

---

### **NOTE**

1. AUTEL accepts no responsibility for any accident or injury arising from servicing the SAS system. When interpreting DTCs retrieved from the vehicle, always follow the manufacturer's recommendation for repair.
  2. All software screens shown in this manual are examples, actual test screens may vary for each vehicle being tested. Observe the menu titles and on-screen instructions to make correct option selections.
  3. Before starting the procedure, make sure the vehicle has ESC. Look for the button on dash.
- 

Take **Wabco** as an example.

#### ➤ **To perform SAS functions**

1. Tap the **Service** application button from the MaxiSys Job Menu.
2. Tap **SAS** button and wait for the vehicle manufacturer screen. You can tap **VIN Scan** or the vehicle make to acquire vehicle VIN information and tap **Yes** to confirm. See [Vehicle Identification](#) on page 19 for detail.

3. Tap Special function to view the sub-function list. The list may vary by test vehicle.

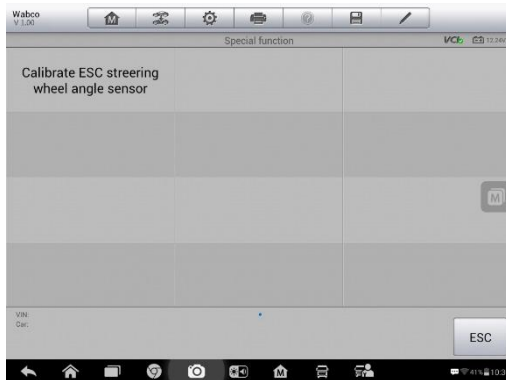
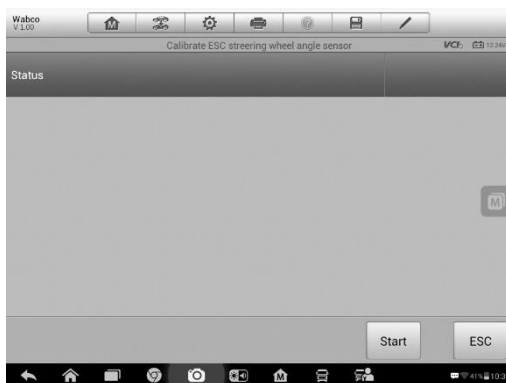

**Figure 5-7 Sample SAS Function Menu**

## Calibrate ESC Steering Wheel Angle Sensor

This function allows users to perform steering angle sensor calibration and clear records. The function options vary with the vehicles being tested.

- 1) Tap **Calibrate ESC Steering Wheel Angle Sensor** from the SAS function menu to enter the function screen.
- 2) Follow the on-screen instructions to set the ignition on/off as guided. The vehicle battery voltage signal should be in the range 12.5 – 13.5 volts to proceed this service, otherwise the scan tablet will display a warning message.
- 3) Make sure the steering wheel is in the central position and the front wheels are in the straight position. Then tap **Start** to calibrate the sensor.



**Figure 5-8 Sample SAS Function Screen 1**

- 4) When the operation is successfully finished, the scan tool will display a confirmation message. Otherwise, it will display a message to remind you of a problem. After you exit the diagnosis program, please repair the problem immediately.

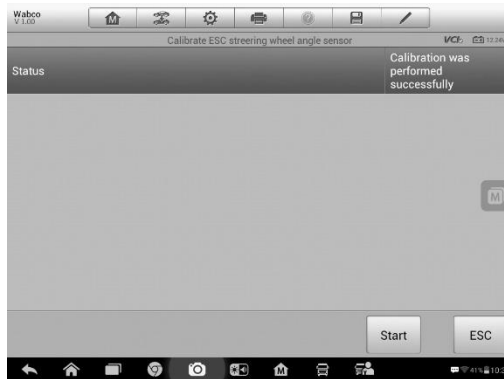

**Figure 5-9 Sample SAS Function Screen 2**

## **DPF Service**

---

The DPF function allows you to carry out numerous functions to the Diesel Particulate Filter system without having to send your car to a main dealer. The tool will manage after treatment particulate matter sensor regeneration, DPF deep clean regeneration, after treatment high nitrogen oxide reset, after treatment selective catalytic reduction system cleaning.

ECM monitors driving style and selects a suitable time to employ regeneration. Cars driven a lot at idling speed and low load will attempt to regenerate earlier than cars driven more with high load and high speed. In order for regeneration to take place, a prolonged high exhaust temperature must be obtained.

In the event of the car being driven in such a way that regeneration is not possible, i.e. frequent short journeys, a diagnostic trouble code will eventually be registered, DPF light and “Check Engine” indicator comes on. A service regeneration can be requested in the workshop, using the diagnostic tool.

Before carrying out a forced DPF regeneration using the tool, check the following items:

- The fuel light is not on.
- No DPF-relevant faults stored in system.
- The vehicle has the correct spec engine oil.
- The oil for diesel is not contaminated.

---

## ! IMPORTANT

Before diagnosing a problem vehicle and attempting to perform an emergency regeneration, it is important to obtain a full diagnostic log and read out relevant measured value blocks.

---

## 🔧 NOTE

1. The DPF will not regenerate if the engine management light is on, or there is a faulty EGR valve.
  2. The ECU must be re-adapted when replacing the DPF and when topping up the fuel additive Eolys.
  3. If the vehicle needs to be driven in order to perform a DPF service, ALWAYS have a second person help you. One person should drive the vehicle while the other person observes the screen on the Tool. Trying to drive and observe the Scan Tool at the same time is dangerous, and could cause a serious traffic accident.
- 

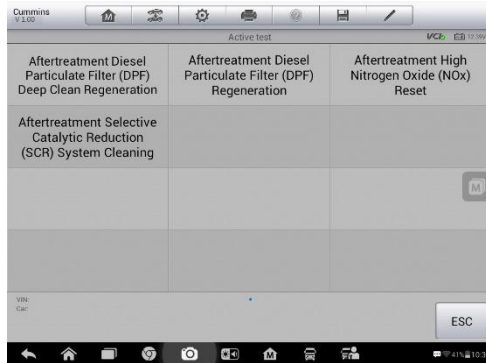
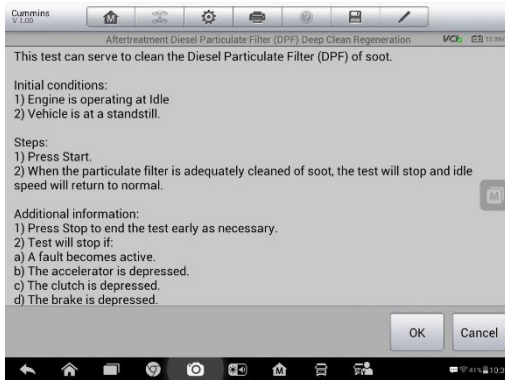

Figure 5-10 Sample DPF Function List

## DPF Deep Clean Regeneration

This function enables you to start fuel delivery matching.

1. Tap **DPF Deep Clean Regeneration** from the service function menu to enter the service screen. This function can clean the DPF of shoot.



**Figure 5-11 Sample DPF Service Screen 1**

2. Tap **OK** to start the service. When the particulate filter is adequately cleaned, the test will stop and idle speed will return to normal.
3. Once the service is completed, the tablet will display “Request is completed”. Please allow time for the engine and after treatment system to cool down.

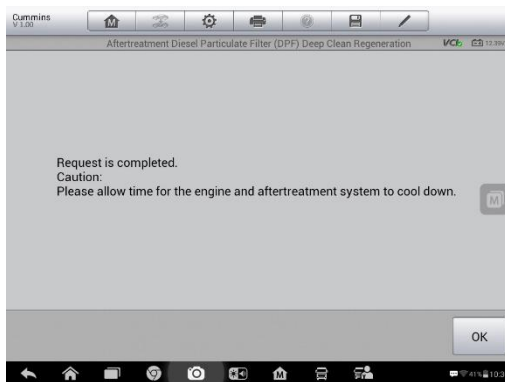

**Figure 5-12 Sample DPF Service Screen 2**

## Cylinder Service

The Cylinder function allows a technician to carry out cylinder bank cutout test, cylinder cutout test, cylinder performance test, single bank cutout test to troubleshoot cylinder misfires. The sub-functions may vary by test vehicle.

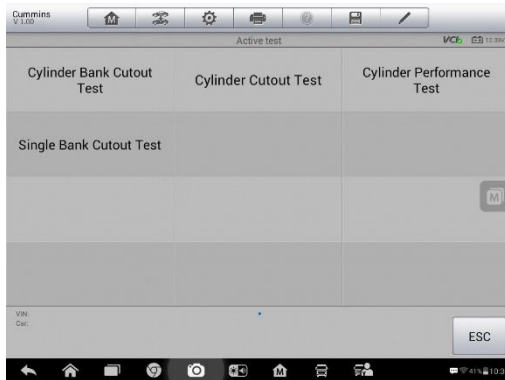
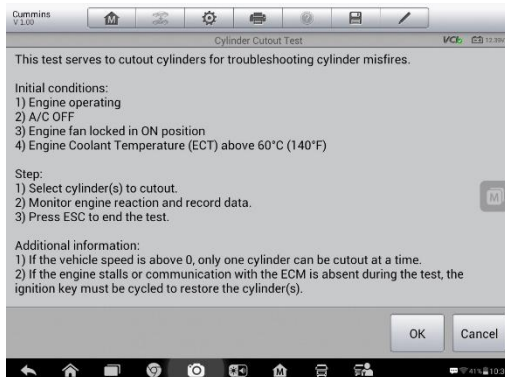

**Figure 5-13 Sample Cylinder Function List Screen**

## Cylinder Cutout Test

This test allow the technician to cutout cylinders for troubleshooting cylinder misfires.

1. Tap **Cylinder Cutout Test** from the service function menu to enter the service screen.



**Figure 5-14 Sample Cylinder Service Screen 1**



2. Tap the Cylinder you want to cutout to test.



**Figure 5-15 Sample Cylinder Service Screen 2**

3. Once the cutout has been successfully carried out, the status will display Cutout.

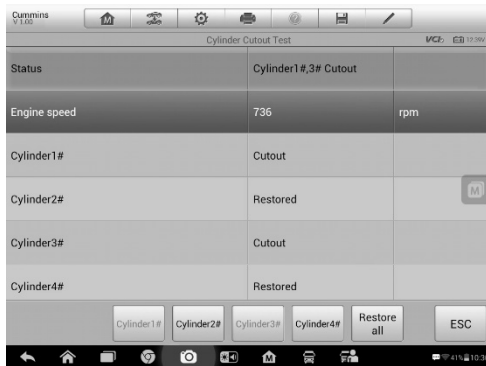

**Figure 5-16 Sample Cylinder Service Screen 3**

4. Tap Restore to restore the cylinders that have been cutout to ensure proper functioning.



**Figure 5-17 Sample Cylinder Service Screen 4**

# Turbo Service

If you think your vehicle might have a turbo-related problem, stop before you replace because turbo damage can often be a symptom of an underlying problem rather than the cause itself. The Turbo function helps a technician to troubleshoot the problem and facilitate accurate installation and calibration of an actuator.

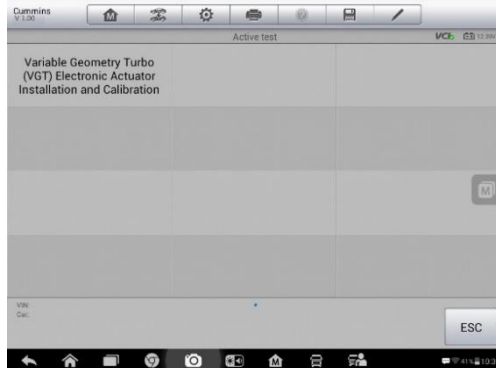

Figure 5-18 Sample Turbo Function List Screen

## VGT Electronic Actuator Installation and Calibration

This procedure serves to facilitate accurate installation and calibration of an actuator when replacing a defective actuator in the field. It is not a functionality test of the actuator. If an attempt is made to use this procedure as a functionality test of the actuator, DTCs and/or the turbo/electric actuator will occur.

1. Tap **AGT Electronic Actuator Installation and Calibration** from the service function menu to enter the service screen.
2. Read the onscreen notification carefully and tap **OK** to proceed.

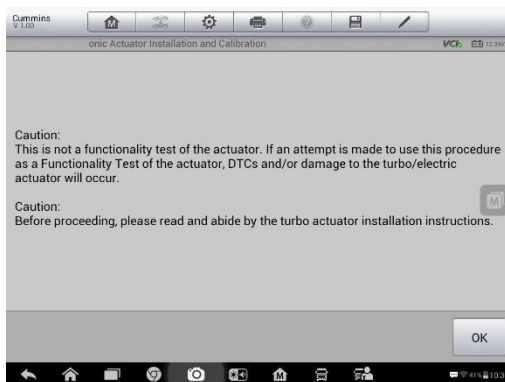
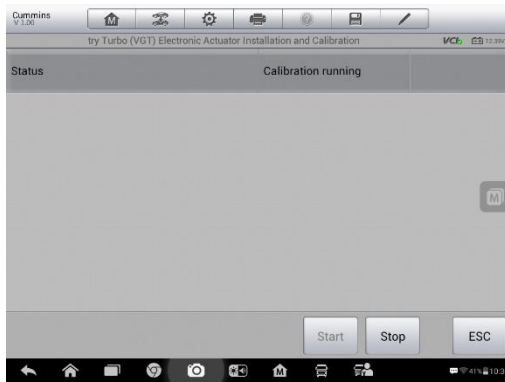

Figure 5-19 Sample Turbo Service Screen 1

3. Tap **Start** to start the service and the status will display the message “Installation is running”.



**Figure 5-20 Sample Turbo Service Screen 2**

4. The screen will display confirmation message once the actuator installation is successfully completed and the VGT actuator can be physically fitted on the turbo. Once the installation is mounted to the turbocharger, tap **OK** to proceed with the calibration.

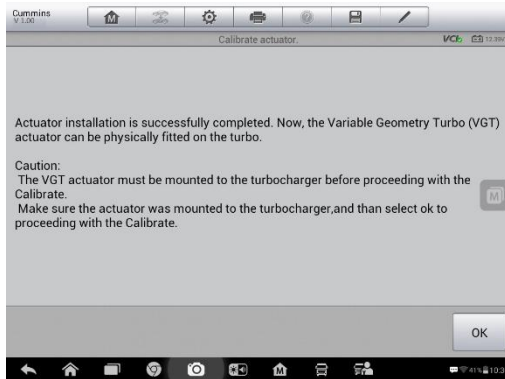

**Figure 5-21 Sample Turbo Service Screen 3**

5. Tap **Start** to start the calibration.

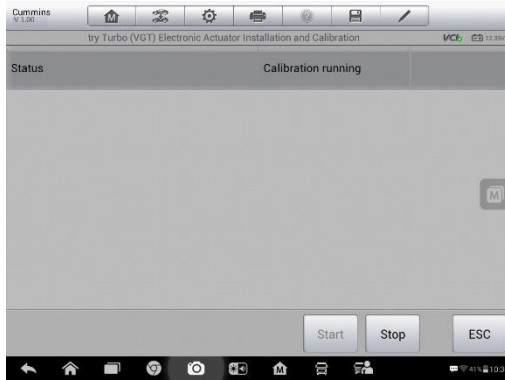

**Figure 5-22 Sample Turbo Service Screen 4**

6. The status will display “Actuator calibration is successfully completed”. Tap **ESC** to exit.

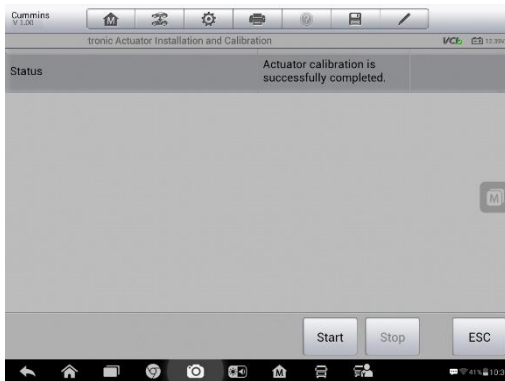

**Figure 5-23 Sample Turbo Service Screen 5**

## Injector Service

---

The barcode printed on each injector must be programmed into the engine DCU every time one or more injectors are replaced. Or when the DCU has been replaced, the new DCU must always be reprogrammed with the codes for all the injectors. If the barcode programmed in the engine DCU is incorrect for the injector, the engine may stall and run very badly at idle. The engine may also break down and have a reduced service life. This function serves to monitor and change injector barcode in the ECM as necessary.

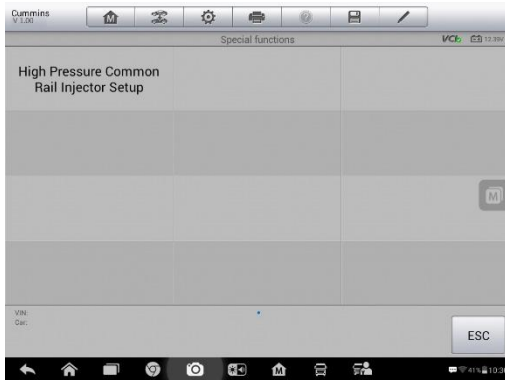

Figure 5-24 Sample Injector Service List Screen

## High Pressure Common Rail Injector Setup

This function serves to monitor and change injector barcode in the ECM as necessary. The injector barcode is marked on the injector during manufacturing. Each time an injector is fitted or replaced, the injector barcode should be updated in the ECM. In the event of an ECM replacement, all of the injector barcodes must be updated.

1. Tap **AGT Electronic Actuator Installation and Calibration** from the service function menu to enter the service screen.
2. Read the onscreen notification carefully and tap **OK** to proceed.

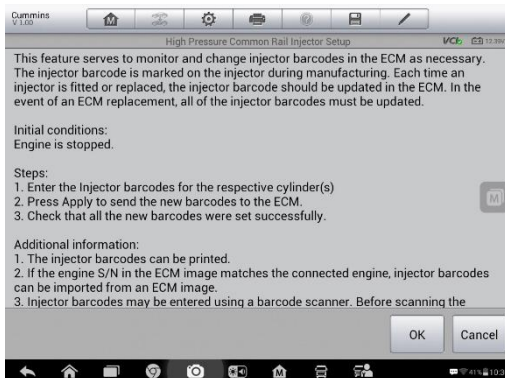

Figure 5-25 Sample Turbo Service Screen 1

3. Tap **Set barcode** button to set the barcode for corresponding cylinder.



**Figure 5-26 Sample Turbo Service Screen 2**

4. Tap **Apply** to set the barcode. Once the setup is successfully done, tap ESC to exit.

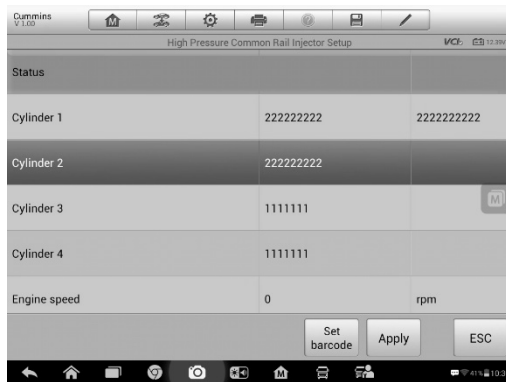

**Figure 5-27 Sample Turbo Service Screen 3**











# 6 Shop Manager

The **Shop Manager** application manages the workshop information, customer information records, and test vehicle history records. There are three main functions available:

- **Vehicle History**
- **Workshop Information**
- **Customer Manager**

The operations of these functions of the Shop Manager application are mainly manipulated by the toolbar buttons, which are listed and described in the table below:

**Table 6-1 Top Toolbar Buttons in Shop Manager**

Button	Name	Description
	<b>Back</b>	Returns to the previous screen.
	<b>Diagnostics</b>	Tap this button to access vehicle Diagnostics menu.
	<b>Enter Edit</b>	Displays the editing toolbar to print or delete the selected file.
	<b>Delete</b>	Deletes the selected vehicle record.
	<b>Search</b>	Enters the vehicle name or test path to retrieve the vehicle record.
	<b>Cancel</b>	Cancels edit or file search.
	<b>Edit</b>	Edits information for the displayed file.
	<b>Add Account</b>	Creates a new customer account file.
	<b>History Notes</b>	Opens a note form. Audio, video, image and text files may be attached.
	<b>Vehicle History</b>	Displays the Vehicle History which the corresponding test vehicle records.
	<b>Done</b>	Completes editing and saves the file.

# Vehicle History

This function stores test vehicle history records, including vehicle information and the retrieved DTCs from previous diagnostic sessions. All information is displayed in summarized details. Tap on a record to resume a diagnostic session on a “stored vehicle”.

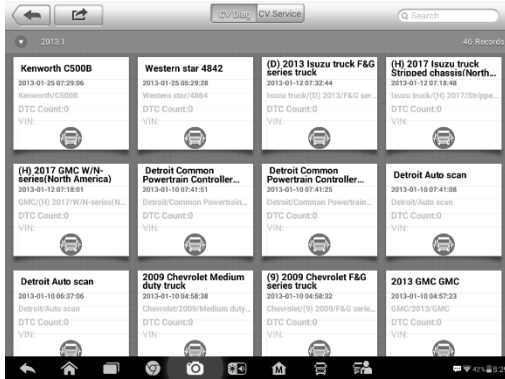

Figure 6-1 Sample Vehicle History Screen

- **To activate a test session for the recorded vehicle**
  1. Tap the **Shop Manager** application on the MaxiSys Job Menu.
  2. Select **Vehicle History**.
  3. Tap the **Diagnostics** button at the bottom of the thumbnail of a vehicle record item.
  4. Or tap the vehicle record thumbnail to view record.
  5. A Historical Test record sheet displays. Check the recorded information of the recorded test vehicle and tap the Diagnostics button on the upper right corner.
  6. The vehicle's Diagnostics screen displays. Now a new diagnostic session is activated, see [CV Diagnostics](#) on page 16 for detailed instructions on vehicle diagnostic operations.



# Historical Test Record

The Historical Test record sheet is a detailed data form that includes general vehicle information such as vehicle year, make and model. The form also includes retrieved DTC from previous test and all information manually inputted by the technician.

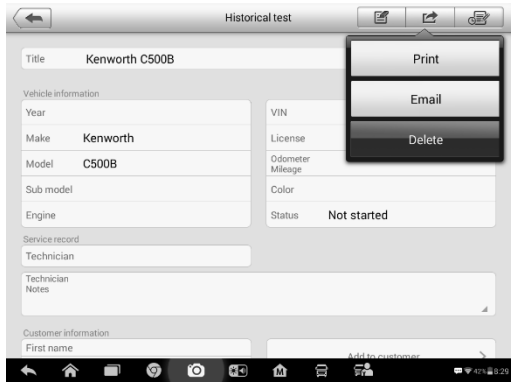

**Figure 6-2 Sample Historical Test Record Sheet**

➤ **To edit the Historical Test record sheet**

1. Tap the **Shop Manager** application on the MaxiSys Job Menu.
2. Select **Vehicle History**.
3. Select the specific vehicle history record thumbnail from the main section. The Historical Test record sheet displays.
4. Tap the **Edit** button to start editing.
5. Tap on each item to input the corresponding information or add attaching files or images.

**NOTE**

The vehicle VIN number, or license and the customer information account are correlated by default. Adding one of the information will automatically associate the other item in the record sheet, provided that the later one exists.

6. Tap **Add to Customer** to supplement the Historical Test record sheet to an existing customer account, or add a new associated account with the test vehicle record. See [Customer Manager](#) on page 59 for more information.
7. Tap **Done** to save the updated record sheet, or tap **Cancel** to exit without saving.

## Workshop Information

---

The Workshop Information form allows you to edit, input and save the detailed workshop information, such as shop name, address, phone number and other remarks, which when printing vehicle diagnostic reports and other associated test file, will display as the header of the printed documents.

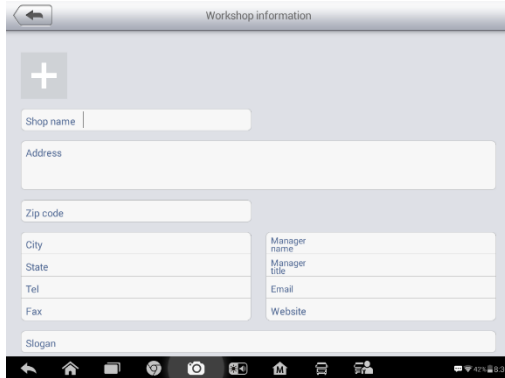

**Figure 6-3 Sample Workshop Information Sheet**

### ➤ To edit the Workshop Information sheet

1. Tap the **Shop Manager** application on the MaxiSys Job Menu.
2. Select **Workshop Information**.
3. Tap the **Edit** button on the top toolbar.
4. Tap on each field to input the appropriate information.
5. Tap **Done** to save the updated workshop information sheet, or tap **Cancel** to exit without saving.

## Customer Manager

---

Use the Customer Manager function to create and edit customer accounts and correlate with the associated test vehicle history records.



### ➤ To create a customer account

1. Tap the **Shop Manager** application on the MaxiSys Job Menu.
2. Select **Customer Manager**.
3. Tap the **Add Account** button. An empty information form displays, tap each field to input the appropriate information.

## NOTE

Required fields are noted.

---

4. Tap the  photo frame beside the Name chart to add a photo. A sub menu displays, select **Take Photo** to take a new photo for the account, or select **Choose Photo** to choose from an existing image.
5. Some customers may have more than one vehicle for service; you can always add new vehicle information to the account to be correlated. Tap **Add New Vehicle Information**, and then fill in the vehicle information. Tap the  button to cancel adding.
6. Tap **Done** to save the account, or tap **Cancel** to exit without saving.

### ➤ **To edit a customer account**

1. Tap the **Shop Manager** application on the MaxiSys Job Menu.
2. Select **Customer Manager**.
3. Select a customer account by tapping the corresponding name card. A Customer Information sheet displays.
4. Tap the **Edit** button on the top toolbar to start editing.
5. Tap on the input field where needs to be altered or supplemented, and enter updated information.
6. Tap **Done** to save the updated information, or tap **Cancel** to exit without saving.

### ➤ **To delete a customer account**

1. Tap the **Shop Manager** application on the MaxiSys Job Menu.
2. Select **Customer Manager** and select a customer account by tapping the corresponding name card. A Customer Information sheet displays.
3. Tap the **Edit** button on the top toolbar to start editing.
4. Tap the **Delete Customer Information** button. A confirmation message displays.
5. Tap **OK** to confirm the command, and the account is deleted. Tap **Cancel** to cancel the request.

## **History Notes**

Use the History Notes function to add audio and video records, text notes and photos for the associated customer account.

### ➤ **To access History Notes**

1. Tap the **Shop Manager** application on the MaxiSys Job Menu.

2. Select **Customer Manager** or **Vehicle History**.
3. Select a customer account by tapping the corresponding name card. A Customer Information sheet displays (if **Customer Manager** is selected). Or, select a vehicle history record item to open the Historical Test record sheet (if **Vehicle History** is selected).
4. Tap the **History Notes** button on the top bar. Now the History Notes screen displays.

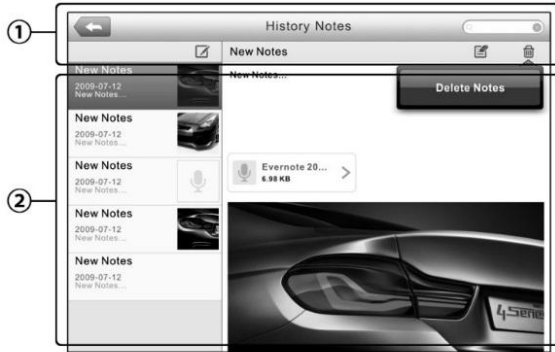

**6-4 Sample History Notes Screen**

1. **Functional Buttons** – navigates and makes various controls of the function.
2. **Main Section** – displays the note list on the left column and the detail information of the selected note on the right column.

**Table 6-2 Function Buttons in History Notes**

Button	Name	Description
	<b>Back</b>	Returns to the previous screen.
	<b>Delete</b>	Deletes the selected note.
	<b>Search</b>	Quickly locates the required note by entering the note title.
	<b>Cancel</b>	Cancels edit or file search.
	<b>Edit</b>	Tap this button to open an edit window to edit notes.
	<b>Add Notes</b>	Adds new note to History Notes.
	<b>Save</b>	Saves notes.

➤ **To add a note in History Notes**

1. Access History Notes.
2. Tap the **Add Notes** button. An edit window displays.
3. Tap on the Title bar to input a note title.
4. Tap on the blank space below to edit a text note or remark.
5. Select a function button on the top to add files in any form you choose.
6. Tap **Save** to save the note; tap **Discard** or **Cancel** to exit without saving.

# 7 Data Manager

The **Data Manager** application is used to store, print, and review the saved files. Most operations are controlled through the toolbar.

Selecting the Data Manager application opens the file system menu. Different file types are sorted separately under different options, there are five types of information files to be viewed or played back.

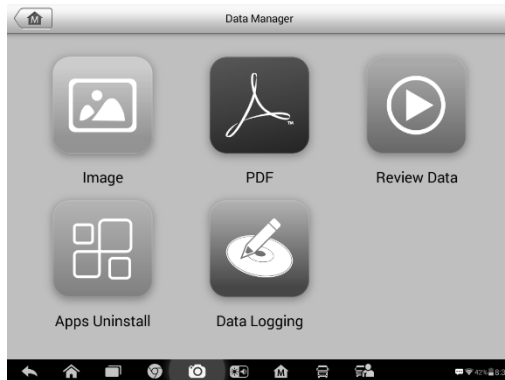

**Figure 7-1 Sample Data Manager Main Screen**

## Operations

---

Data Manager Operations are based on toolbar controls. Details are explained in the following sections.

### Image Files



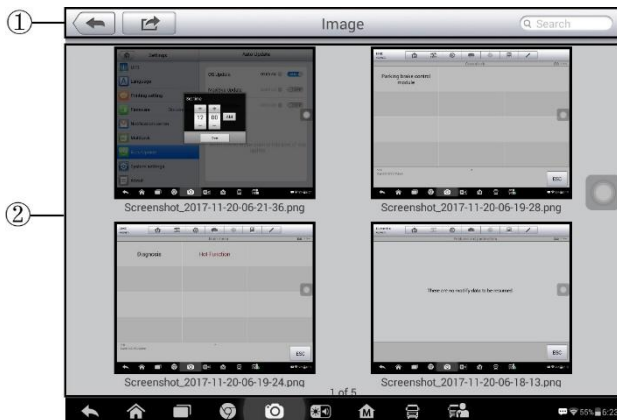



The Image section contains all captured screenshot images.



**Figure 7-2 Sample Image Screen**

1. **Toolbar Buttons** – used to edit, print and delete the image files. See the following table for detailed information.
2. **Main Section** – displays the stored images.

**Table 7-1 Toolbar Buttons in Image Screen**

Button	Name	Description
	<b>Back</b>	Returns to the previous screen.
	<b>Enter Edit</b>	Tap this button to display the editing toolbar. Print, delete or view image information.
	<b>Cancel</b>	Tap this button to close the editing toolbar or cancel file search.
	<b>Search</b>	Quickly locates the image file by entering the vehicle name, test path, file name or file info.
	<b>Info</b>	Tap this button to display the details.
	<b>Print</b>	Tap this button to print the selected image.
	<b>Delete</b>	Tap this button to delete the selected image.

➤ **To edit image information**

1. Select **Data Manager** application from the MaxiSys Job Menu.

2. Select **Image** to access the image database.
3. Select an image to display in full screen.
4. Tap the screen to display the editing toolbar.
5. Tap the **Info** button to display image information.
6. Tap the **Edit** button on the top right corner of the window. The editing screen displays.
7. Edit the image information by entering the new file name, and file information.
8. Tap **Done** to save the information and exit, or tap **Cancel** to exit without saving.

---

 **NOTE**

The printer driver program must be installed in order for the tablet's Wi-Fi printer capabilities can be used.

---

➤ **To install the printer driver program**

8. Please download the **Maxi PC Suite** from [www.autel.com](http://www.autel.com) > Support & Updates > Firmware & Downloads > UPDATE CLIENT, and install to your windows-PC. The Maxi PC Suite consists of Autel Printer, MaxiSys Pinter and PC Suite.
9. Double click on **Setup.exe** item.
10. Select the installation language and the printer driver installation wizard will load momentarily.
11. Follow the wizard instructions on the screen and click **Next** to continue.
12. Click on **Install** and the printer driver program will be installed onto the computer.
13. Click on **Finish** to complete the installation procedure.

➤ **To delete selected images**

1. Select **Data Manager** application from the MaxiSys Job Menu.
2. Select **Image** to access the JPG database.
3. Tap the **Enter Edit** button to display the editing toolbar.
4. Select the images that need to be deleted by tapping the thumbnail images, the selected thumbnail displays a tick icon at the bottom right corner.
5. Tap the **Delete** button, and then **Delete Selected**, then the selected images will be deleted.

## PDF Files

The PDF section stores and displays all saved data PDF files. Select a PDF file from the database to display.



The standard Adobe Reader application is used for file viewing and editing, please refer to the associated Adobe Reader manual for detailed instructions.

## Review Data

The Review Data section allows playback of the recorded data frames of live data streams.

On the Review Data main screen, select a record file to playback.

Name	Value	Unit
<input type="checkbox"/> Turbo speed	8000	rpm
<input type="checkbox"/> Intake manifold temperature	16	*F
<input type="checkbox"/> Air inlet pressure	4	psi
<input type="checkbox"/> Air filter differential pressure	0.12	psi
<input type="checkbox"/> Coolant pressure	2	psi
<input type="checkbox"/> Engine coolant temperature	16	*F
<input type="checkbox"/> Coolant level	8	%
<input type="checkbox"/> Engine retarder status	OFF	
<input type="checkbox"/> 8 Cylinder engine retarder status	Active	

**Figure 7-3 Sample Data Playback Screen**

1. Drop-down Toolbar – tap the button at the top center of the screen to open the Drop-down Toolbar.
2. Main Section – displays the recorded data frames.
3. Navigation Toolbar – controls data playback.

Use the Navigation Toolbar buttons to playback the record data from frame to frame.

Tap **Back** to exit data playback.

## Apps Uninstall

This section manages the firmware applications installed on the MaxiSys Diagnostics System. Select this section to open a management screen, on which you all the available vehicle diagnostic application can be reviewed.

Tap on the vehicle manufacturer icon that you wish to delete. The selected icon will display a blue check at the upper right corner. Tap the **Delete** button on the top bar to delete the firmware from the system database.

## Data Logging

The Data Logging section allows you to launch Support platform directly to view all records of all sent or unsent (saved) data loggings on the diagnostic system. For more details, please refer to [Data Logging](#) on page 85.

# 8 Settings

Tap the **Settings** button to adjust the default setting and view information about the MaxiSys system. There are nine options available for the MaxiSys system settings:

- **Unit**
- **Language**
- **Printing Setting**
- **Firmware**
- **Notification Center**
- **Multitask**
- **Auto Update**
- **System Settings**
- **About**

This section describes the procedures to adjust the device's system settings.

## Unit

---

This option allows you to adjust the measurement unit for the diagnostic system.

### ➤ **To adjust the unit setting**

1. Tap the **Settings** application on the MaxiSys Job Menu.
2. Tap the **Unit** option on the left column.
3. Select the appropriate measurement unit, Metric or English. A tick icon will display to the right of the selected unit.
4. Tap the **Home** button on the top left corner to return to the MaxiSys Job Menu. Or select another setting option for system setup.

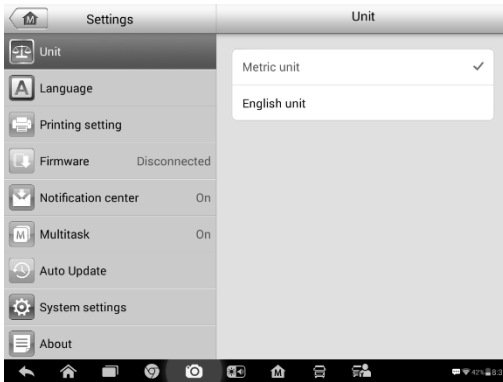

**Figure 8-1 Sample Unit Setting Screen**

## Language

This option allows you to adjust the display language for the MaxiSys system.

➤ **To adjust the language setting**

1. Tap the **Settings** application on the MaxiSys Job Menu.
2. Tap the **Language** option on the left column.



**Figure 8-2 Sample Language Setting Screen**

3. Select the appropriate language. A check will display to the right of the selected language.
4. Tap the **Home** button on the top left corner to return to the MaxiSys Job Menu, or tap another setting to adjust.

# Printing Setting

---

Configure this option to enable the tablet to print through a specified Wi-Fi network connection.

➤ **To setup the printer connection**

1. Tap the **Settings** application on the MaxiSys Job Menu.
2. Tap the **Printing Setting** option on the left column.
3. Tap the **Print via Network** item to activate the printing function, which enables the device to send files to the printer through the networked PC via Wi-Fi connection.
4. Tap the **Home** button on the top left corner to return to the MaxiSys Job Menu, or tap another setting to adjust.

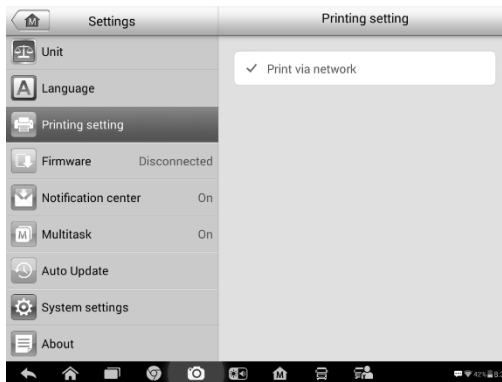

**Figure 8-3 Sample Printing Setting Screen**

## Printing via APP

MS906CV provides the most convenient printing method, printing via APP.

To realize this function, please make sure a Wi-Fi printer is available and then purchase a Wi-Fi printer APP and install it onto your tablet.

By a simple click on the Print button of a saved file on the tablet, the file will be printed automatically.

## Printing via PC

If the Wi-Fi printer is not available, you can also use your windows-PC to print the data on the tablet. Follow the instructions below to realize this function.

➤ **To install the printer driver program to a computer**

1. Download the **Maxi PC Suite** from [www.autel.com](http://www.autel.com) and install to your windows-PC.
2. Double click on **Setup.exe** item.
3. Select the installation language and the wizard will load momentarily.
4. Follow the instructions on the screen and click **Next** to continue.
5. Click on **Install** and the printer driver program will be installed onto the computer.
6. Click on **Finish** to complete the installation.

---

🔗 **NOTE**

The MaxiSys Printer runs automatically after the installation. The computer, printer and the tablet must be connected to the same network.

---

➤ **To perform printing through the computer**

1. Run the **MaxiSys Printer** program on the computer.
2. Click **Test Print** to make sure the printer is working successfully.
3. Tap the **Print** button on the toolbar. A temporary document will be created and sent to the computer for printing and the received document automatically when the **Auto Print** option is selected.
4. Tap the **Print** button on the toolbar of the tablet. A test document will be sent to the computer.
  - ✧ If the **Auto Print** option in the MaxiSys Printer is selected, the MaxiSys Printer will print the received document automatically.
  - ✧ If the **Auto Print** option is not selected, click **Open PDF File** button to view all the temporary files. Select the file(s) to print and click **Print**.

## Firmware

---

This option allows you to update the firmware of the diagnostic tool. Connect the diagnostic tablet with the vehicle through DLC or use the mini USB cable for power supply. Follow the on-screen instructions to complete the operation. Internet connection is necessary for this operation.

# Notification Center

---

This option allows you to turn the Notification Center function on or off. The Notification Center function configures the MaxiSys tablet to receive regular on-line messages from the server for system update notifications or other service information via the Internet. It is highly recommended to keep this function ON all the time, to ensure notifications of updates are received. Internet access is required for receiving on-line messages.

➤ **To enable the Notification Center function**

1. Tap the **Settings** application on the MaxiSys Job Menu.
2. Tap the **Notification Center** option on the left column.
3. Tap the **ON/OFF** button to enable or disable the Notifications function. If the function is enabled the button turns blue, or if disabled the button turns gray.

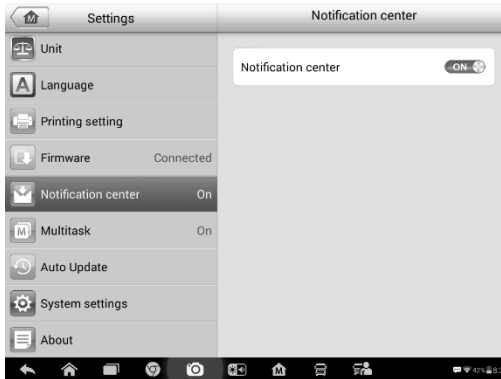

**Figure 8-4 Sample Notification Screen**

4. Tap the **Home** button on the top left corner to return to the MaxiSys Job Menu or choose another setting to adjust.

When the Notification Center function is turned on, and new messages are received by the MaxiSys device, a notification message displays on the MaxiSys Job Menu. Press on the message bar and drag it down, and the received messages are shown in the list. Swipe up or down to view if the message list populates additional screen.

Tap a specific message to launch the corresponding application. For example, tap on an Update notification message and the Update application will launch.

# Multitask

---

The Multitask option allows you to turn the Multitask function on or off. The Multitask feature enables you to browse and navigate more freely among different applications

on the MaxiSys system. Tap the Multi Task button, the Multi Task menu displays all active applications.

➤ **To enable the Multitask function**

1. Tap **Settings** on the MaxiSys Job Menu.
2. Tap **Multitask** on the left column.
3. Tap **ON/OFF** to enable or disable the Multitask function. If the function is enabled the button displays blue, or if disabled the button displays gray.

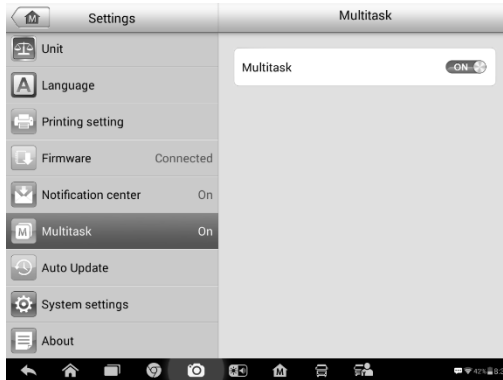

**Figure 8-5 Sample Multitask Screen**

4. Tap **Home** on the top left corner to return to the MaxiSys Job Menu. Or select another setting option to configure another system setting.

## Auto Update

---

The Auto Update allows the tool to automatically update the OS, the MaxiSys system, and the Vehicle coverage software. Each can be configured to update automatically at specified times. Tap the **ON/OFF** button and set the desired automatic update time.

➤ **To set auto system or vehicle update**

1. Tap the **Settings** application on the MaxiSys Job Menu.
2. Tap the **Auto Update** option on the left column. The three auto update items display on the right.



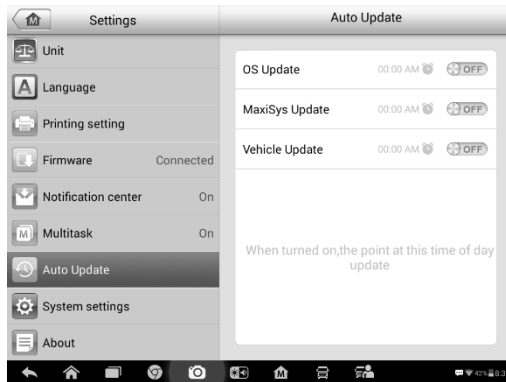

**Figure 8-6 Sample Auto Update Screen**

3. Select the update type to schedule. Toggle the button to ON.
4. To set download time, use the + and – button or tap on the numbers and the manual input screen will display. Tap **Done** to complete the time setting.

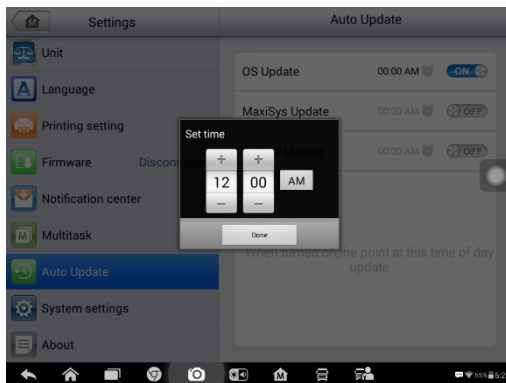

**Figure 8-7 Sample Set Time Screen**

**NOTE**

The tool must be connected to the Internet at the time download is scheduled.

## System Settings

Access the Android system setting interface to adjust background system settings including wireless and network settings, sound and display screen settings and system security settings.

- **To enable the App Switcher function**

1. Tap the **Settings** application on the MaxiSys Job Menu.
2. Tap the **System settings** option on the left column.

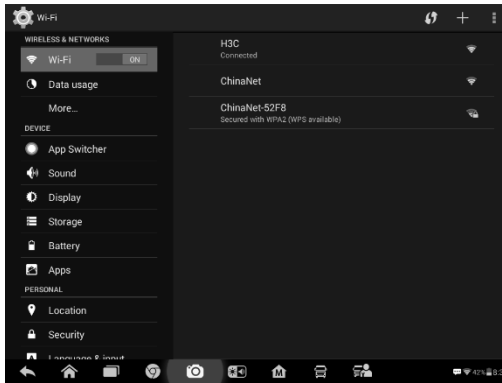

**Figure 8-8 Sample System Settings Screen**

3. Tap the **App Switcher** option on the left column.
4. Check the box beside “Always show the App Switcher” on the right side of the screen, then the App Switcher icon will display.

Short pressing the App Switcher icon opens a control panel:

- Tap a specific app shortcut button to access selected application screen.
- Long press a specific app shortcut button to display the app menu. The shortcut can be altered here.
- Press and drag the App Switcher icon to alter the icon position on the screen.

Refer to Android documentation for additional information about Android system settings.

## About

---

About displays information regarding the MaxiSys diagnostic device including the product name, version, hardware, and serial number.

### ➤ To check the MaxiSys product information in About

1. Tap the **Settings** application on the MaxiSys Job Menu.
2. Tap the **About** option on the left column. The product information screen displays on the right.
3. Tap the **Home** button on the top left corner to return to the MaxiSys Job Menu or select another setting to adjust.

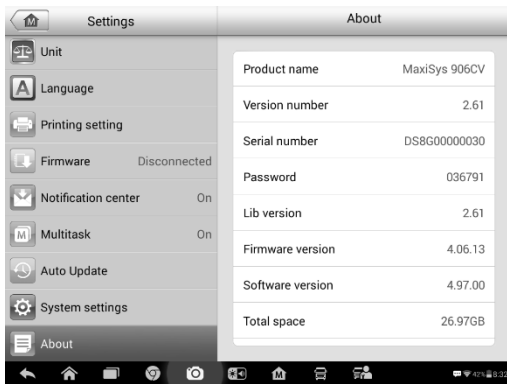

**Figure 8-9 Sample About Screen**

# 9 Update

The internal programming of the MaxiSys Diagnostic System, known as the firmware, can be updated using the Update application. Firmware updates increase the MaxiSys applications' capabilities, typically by adding new tests, new models, or enhanced applications to the database.

The display device automatically searches for available updates for all of the MaxiSys components when it is connected to the Internet. Any updates that are found can be downloaded and installed on the device. This section describes installing an update to the MaxiSys Diagnostic System firmware. A notification message displays if an update is available when the Notifications function is enabled in the Settings application (See [Notification Center](#) on page 72).



**Figure 9-1 Sample Update Screen**

1. Navigation and Controls
  - Home Button – returns to the MaxiSys Job Menu.
  - Update All – available updates for all tablet systems.
  - Search Bar – searches specific update item by inputting the file name, for example: a specific vehicle manufacturer.
2. Status Bar
  - Left Side – displays the MaxiSys device model information and serial number
  - Right Side – displays an update progress bar indicating the completion status

### 3. Main Section

- Left Column – displays vehicle logos and update firmware version information.
- Middle Column – displays a brief introduction about the new changes to the firmware operation or capabilities. Tap **i** button to display an information screen to view more details, and tap the dim area around to close the window.
- Right Column – according to the operation status of each firmware item, the button displays differently.
  - a) Tap **Update** to update the selected item.
  - b) Tap **Pause** to suspend the updating procedure.
  - c) Tap **Continue** to go on updating the suspended update.

#### ➤ **To update the firmware**

1. Power up the tablet, and ensure that it is connected to a power source and has a steady Internet connection.
2. Tap the **Update** application button from the MaxiSys Job Menu; or tap the update notification message when received. The Update application screen displays.
3. Check all available updates:
  - If you decide to update all the items, tap the **Update All** button.
  - If you only want to update some individual items, tap the **Update** button on the right column of the specific item.
4. Tap the **Pause** button to suspend the updating process. Tap **Continue** to resume the update and the process will continue from the pause point.
5. When the updating process is completed, the firmware will be installed automatically. The new version will replace the older version.

# 10 Function Viewer

The Function Viewer allows you to search the functions supported by our tools and the software version information. There are two ways of searching, either by searching the tool and the vehicle or searching the functions.

➤ **To search by the vehicle**

1. Tap the **Function Viewer** application on the MaxiSys Job Menu. The Function Viewer application screen displays.
2. Tap the tool name on the top left to drop down the tool list, tap the one you want to search.



**Figure 10-1 Sample Function Viewer Screen 1**

3. Tap the vehicle brand, model, and year you want to search.
4. All the functions support by the selected tool for the selected vehicle displays with three column, function, sub function, and version.

Year	System	Sub system	Type	Function	Sub function	Version
/	Brake	EC-17	Bus	Ecu Information	/	Above CVBBlueb...
/	Brake	EC-17	Bus	Erase Codes	/	Above CVBBlueb...
/	Brake	EC-17	Bus	Live Data	/	Above CVBBlueb...
/	Brake	EC-17	Bus	Read Codes	/	Above CVBBlueb...
/	Brake	EC-17	Bus	Special Function	Reset Brake Controller	Above CVBBlueb...
/	Brake	EC-30	Bus	Ecu Information	/	Above CVBBlueb...
/	Brake	EC-30	Bus	Erase Codes	/	Above CVBBlueb...

**Figure 10-2 Sample Function Viewer Screen 2**

➤ **To search by the functions**

1. Tap the **Function Viewer** application on the MaxiSys Job Menu. The Function Viewer application screen displays.
2. Tap the tool name on the top left to drop down the tool list, tap the one you want to search.
3. Type in the function you want to search to the top right search column. All the vehicles with this function will be listed with 8 columns, the Brand, Model, Year, System, Sub system, Function, Sub function, and Version.

**NOTE**

Fuzzy search is supported, type in part of the function you want to search can also find you all the related.

# 11 Support

This application launches the Support platform which synchronizes Autel's on-line service base station with the tablet. In order to synchronize the device to your on-line account, you need to register the product through the Internet when you use it for the first time. The Support application is connected to Autel's service channel and on-line communities which provides the quickest way for problem solutions, allowing you to submit complaints or sent help requests to obtain direct services and supports.

## Product Registration

---

Register your MaxiSys Diagnostic Device to access the Support platform and download update.

### ➤ To register the diagnostic device

1. Visit the website: <http://pro.autel.com>.
2. If you already have an Autel account, Sign In with your account ID and password.
3. If you are a new member to Autel, click on the **Create Autel ID** button on the left side of the screen to create an ID.
4. Enter the required information in the input fields, read through Autel's Terms and Conditions and tick on **Agree**, and then click **Create Autel ID** at the bottom to continue.
5. The online system will automatically send a verification code to the registered email address. Input the code in the Verification code field and complete other required fields. Read through Autel's Terms and Conditions and click on **Agree**, and then click **Create Autel ID** at the bottom. A product registration screen will display.
6. The device's serial number and password is located in the About section of the Settings application screen will display.
7. Select your product model, enter the product serial number and password on the Product Registration screen, and click **Submit** to complete the registration procedure.



# Support Screen Layout

---

The Support application interface is navigated via four simple buttons on the top navigation bar, operation of each is described below in turn from left to right:

- Home Button – returns to the MaxiSys Job Menu.
- Back – returns to the previous screen, each press takes you back one step.
- Forward – each press moves forward one screen until you've reached the last screen visited.
- Refresh – reloads and updates the screen.

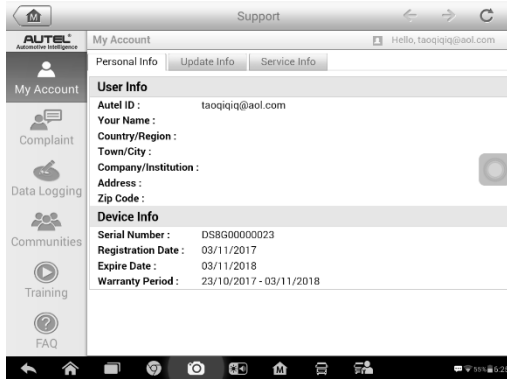

**Figure 11-1 Sample Support Application Screen**

The main section of the Support screen is divided into two sections. The narrow column on the left is the main menu; select one subject from the main menu to display the corresponding functional interface on the right.

## My Account

---

The My Account screen displays the comprehensive information of the user and the product, which is synchronized with the on-line registered account, including User Info, Device Info, Update Info and Service Info.

### Personal Info

The User Info and Device Info are both included under the Personal Info section.

- User Info - displays detailed information of your registered on-line Autel account, such as your Autel ID, Name, Address and other contact information, etc.
- Device Info – displays the registered product information, including the Serial

Number, Registration Date, Expire Date, and Warranty Period.

## Update Info

The Update Info section displays a detailed record list of the product's software update history, including the product serial number, software version or name, and the update time.

## Service Info

The Service Info section displays a detailed record list of the device's service history information. The device's serial number and a detailed repair report, such as the fault type, changed components, or system reinstallation, will be listed.

## User Complaint

---

The User Complaint screen allows you to establish a new complaint case, as well as to view historical complaint records.

The User Complaint screen consists of two parts.

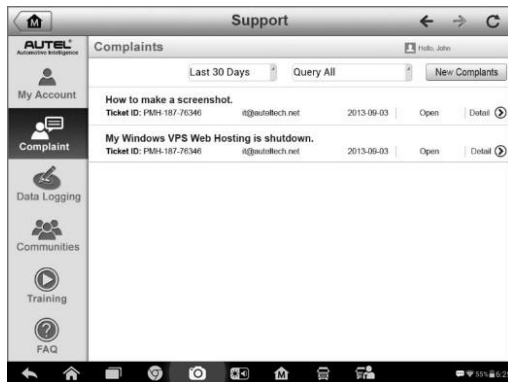

**Figure 11-2 Sample Complaint Screen**

1. Option Bar
  - Period Filter – displays only the complaint records within the defined period on the list.
  - Status Filter – displays the corresponding complaint records according to the selected case status.
  - New Complaint Button – starts a new complaint case.
2. Complaint List

The complaint list normally displays all the complaint records of all time and all status by default. The summary information for each complaint item includes the Subject Name, Ticket ID, User's Account ID, Date, and the Case Status.

There are four case status types:

- Open – indicates the complaint case has been started but not processed.
- Suspended – indicates the complaint case is being processed.
- Waiting Customer Reply – indicates the complaint has been replied by the service personnel, and requires feedback from the customer.
- Closed – indicates the complaint case has been processed, resolved, and closed.

To view the detailed complaint session, tap the  button on the right side of the case item.

#### ➤ **To establish a new complaint session**

1. Register the product online.
2. Tap the **Support** application on the MaxiSys Job Menu. The device information is automatically synchronized with the online account.
3. Tap **Complaint** on the Main Menu.
4. Tap the **New Complaint** button at the upper right corner. A selection menu with a category of service channels displays.
5. Select a target service channel and click **Next** to continue. A standard complaint form displays, on which you are allowed to enter detailed information, such as personal information, vehicle information, and device information, you can also attach image or PDF files with the form.
6. Enter in each input field the appropriate information. In order to settle the complaint more efficiently, it is recommended to fill out the complaint form as completely as possible.
7. Select the required processing time on the last section according to the urgency of the case.
8. Tap **Submit** to send the completed form to Autel's online service center, or tap **Reset** to refill it. The submitted complaints will be carefully read and handled by the service personnel, and the respond speed may depend on the processing time you've required.

#### ➤ **To make a reply in a complaint session**

1. Register the product online.
2. Tap the **Support** application on the MaxiSys Job Menu. The device information is automatically synchronized with the online account.
3. Tap **Complaint** on the Main Menu.

4. Select an existing complaint case item on the record list by tapping the  button on its right side. The screen displays the complaint session details.
5. Tap the **Post Reply** button on the upper right side after viewing, to make a reply. An edit screen displays.
6. Input the content in the input field, and if necessary, upload an attaching file.
7. Tap **Submit** to post the reply.
8. Tap the **States** selection drop-down menu to reset a case state.
9. Tap the **Update** button to commit the newest update.

## Data Logging

The Data Logging section keeps records of all sent or unsent (saved) data loggings on the diagnostic system. The support personnel receive and process the submitted reports through the Support platform, and send back problem solutions within 48 hours. Support personnel will answer your questions directly.

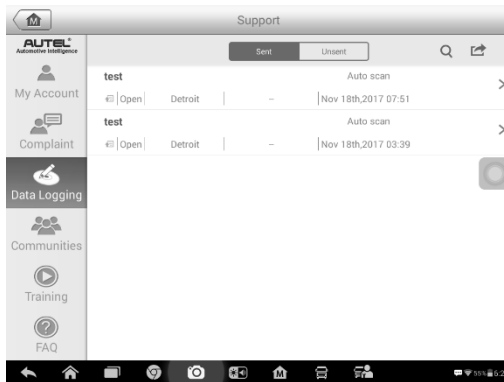

**Figure 11-3 Sample Data Logging Screen**

### ➤ To make a reply in a Data Logging session

1. Tap on the **Sent** tag to view a list of submitted data loggings.
2. Select a specific item to view the latest update.
3. Tap on the input field at the bottom of the screen, and enter texts. Or tap the Audio button to record a voice message or camera button to include an image.
4. Tap **Send** to send message to the technical center.

# Communities

The Communities section launches and synchronizes with the Technical Forums on Autel's official website [www.autel.com](http://www.autel.com), where you are allowed to discuss technical topics or share information with, as well as ask for technical advices or offer technical supports to all other members in Autel's online support communities.

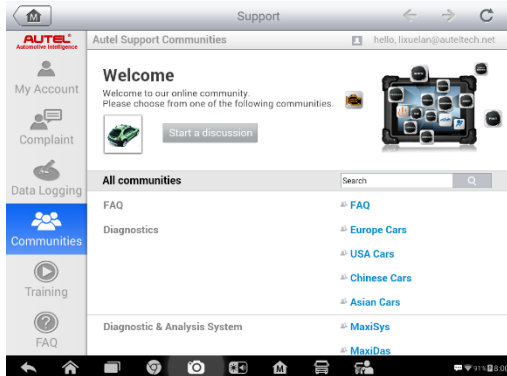



Figure 11-4 Sample Communities Home Screen

## ➤ To start a discussion

1. Tap **Start a discussion** on the Communities Home screen. A list of the major forums is displayed.
2. Select the appropriate device heading. For example, if you are going to ask a question about the MaxiSys tablet, tap **MaxiSys** to start a discussion.
3. Enter your topic and the discussion content in the appropriate input field.
4. Select a category or edit tags for the discussed post. This will help other members with similar interest to find your post.
5. Tap **OK** to submit the post.

## ➤ To join and reply to a discussion post

1. Select a forum group, whether by the product or the features, on the Communities Home screen. A list of the latest posts is displayed.
2. Select a specific category on the Categories menu to better pinpoint the topics you are most interested with.
3. Tap the  button on the right side of the topic item to view the discussion. The posts contents are displayed.
4. Browse through all the posts by sliding the screen up and down. Tap **Go to original post** when reaching the end of the discussion to return to the first post.

5. Tap **Reply** to reply a specific post, or tap **Reply to original post** to join and continue the whole discussion.
6. Enter your comment in the input field, and tap **OK** to submit your post.

## User Profile

The User Profile section allows you to set personal Avatar, check your member status and other information, as well as to review your personal posts in the communities.

Tap the Avatar image on the Communities screen to open the User Profile.

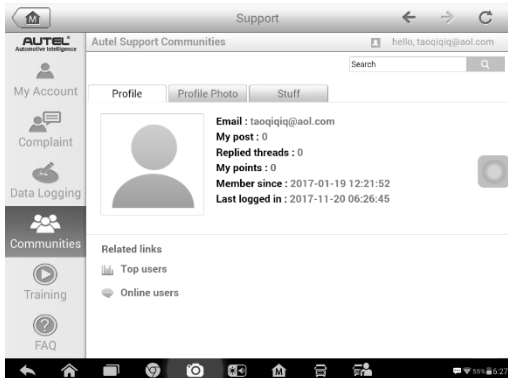

**Figure 11-5 Sample User Profile Screen**

- Profile – displays the user’s personal information and member status. The **Related links** allow you to check the Top Users (ranked according to their points and levels) in the communities, as well as to find out other online users.
- Avatar – allows you to select an image to set as your personal Avatar to be displayed in the communities.
- Stuff – displays all the discussions you’ve posted at various forums in a list.

## Training Channels

The Training section provides quick links to Autel’s online video accounts. Select a video channel by the language to see all the available online tutorial videos from Autel for various technical supports, such as product usage techniques and vehicle diagnostics practice.

## FAQ Database

---

The FAQ section provides you comprehensive references for questions frequently asked and answered about the use of Autel's online member account, and shopping and payment procedures.

- Account – displays questions and answers about the use of Autel's online user account.
- Shopping & Payment – displays questions and answers about online product purchase and payment methods or procedures.

# 12 Academy

Autel provides various tutorial articles and technical bulletins produced by top-notch technicians and product experts. Please view the materials that are saved on the tablet or view technical articles from our online forum by clicking the links displayed under this application.

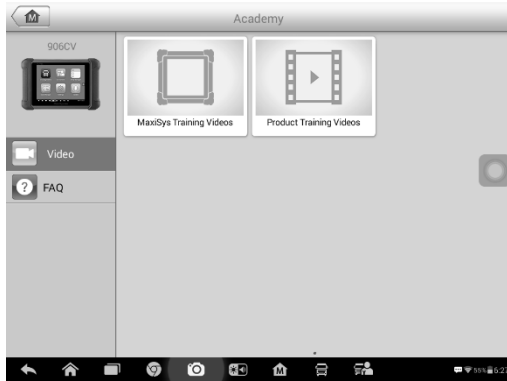

**Figure 12-1 Sample Academy Screen**



# 13 Remote Desk

The Remote Desk application launches the TeamViewer Quick Support program, which is a simple, fast and secure remote control screen. You can use the application to receive ad-hoc remote support from Autel's support center, colleagues, or friends, by allowing them to control your MaxiSys tablet on their PC via the TeamViewer software.

If you think of a TeamViewer connection as a phone call, the TeamViewer ID would be the phone number under which all TeamViewer Clients can be reached separately. Computers and mobile devices that run TeamViewer are identified by a globally unique ID. The first time the Remote Desk application is started, this ID is generated automatically based on the hardware characteristics and will not change later on.

Make sure the tablet is connected to the Internet before launching the Remote Desk application, so that the tablet is accessible to receive remote support from the third party.

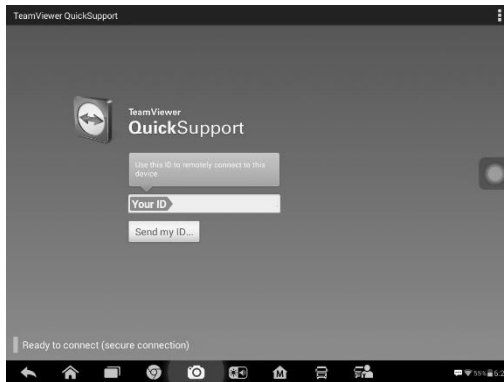

**Figure 13-1 Sample Remote Desk Screen**

- **To receive remote support from a partner**
  1. Power on the tablet.
  2. Tap the **Remote Desk** application on the MaxiSys Job Menu. The TeamViewer screen displays and the device ID is generated and shown.
  3. Your partner must install the Remote Control software to his/her computer by downloading the TeamViewer full version program online (<http://www.teamviewer.com>), and then start the software on his/her computer at the same time, in order to provide support and take control of the tablet

remotely.

4. Provide your ID to the partner, and wait for him/her to send you a remote control request.
5. A popup displays to ask for your confirmation to allow remote control on your device.
6. Tap **Allow** to accept, or tap **Deny** to reject.

Refer to the associated TeamViewer documents for additional information.

# 14 Quick Link

The Quick Link application provides convenient access to Autel's official website and to additional in automotive service sites.

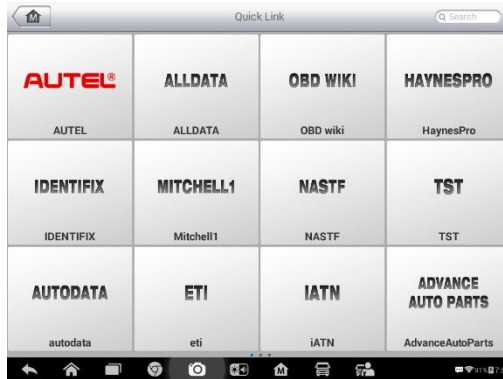

**Figure 14-1 Sample Quick Link Screen**

➤ **To open a quick link**

1. Tap the **Quick Link** application on the MaxiSys Job Menu. The Quick Link application screen displays.
2. Select a website thumbnail from the main section. The Chrome browser is launched and the selected website is opened.

# 15 MaxiFix

The MaxiFix application launches the on-line troubleshooter database, which not only provides you virtually all common diagnostic trouble code (DTC) database for most vehicles, but also serves as a forum allowing you to network with other MaxiSys users, and gives you access to a vast database of repair and diagnostic tips along with proven filed fixes.

While the MaxiFix database keeps growing with daily troubleshooting resources and the advisory reports from the MaxiSys users from all over the world.

Information in the MaxiFix database is organized into a series of diagnostic tips that are designed to quickly lead you to the root cause of a particular problem on the test vehicle.

## Navigation

You need to register the device to your online account before launching the MaxiFix platform, see [Product Registration](#) on page 81 for details.

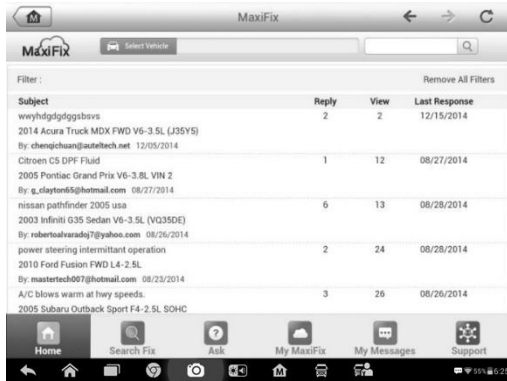

Figure 15-1 Sample MaxiFix Home Page

The MaxiFix screen layout consists of three main areas:

1. The Header – the tool bar across the top of the screen which allows you to select vehicles and perform searches.
2. The Main Screen – located at the center of the screen displaying content based on the vehicle attributes and keywords specified. The tabs on the main screen vary in

accordance with the section selected on the Navigation Menu, allowing you to switch between functions.

3. The Navigation Menu – the main menu at the bottom of the screen, which provides you access to different sections of MaxiFix.

## The Header

The Header at the top of the screen features:

- A **Select Vehicle** button to open the vehicle identification window, and vehicle information bar, for example “2014 > Hyundai > Accord Coupe > L4-2.4L (K24W1)”.
- A search field to find relevant information by entering keywords, codes, or problems.

## Select Vehicle Button

The **Select Vehicle** button on the Header allows you to specify the vehicle which you want to research on MaxiFix, by selecting each of the vehicle attribute from a sequence of option lists. This feature helps to filter out the searches that allow only the information that applies to the identified vehicle to display.

---

### NOTE

All attributes must be specified to make a complete vehicle selection for the most efficient search results.

---

#### ➤ To select a vehicle

1. If you haven't already done so, click the **Select Vehicle** button on the Header.
2. Select the **year** of the vehicle from the list.
3. Select the **make** of the vehicle from the list.
4. Select the **model** of the vehicle from the list.
5. Select the **submodel** of the vehicle from the list.
6. Select the **engine** of the vehicle from the list.

After completing the vehicle selection procedure, the identified vehicle is shown on the Header.

## Terminology

### *MaxiFix Tip*

A MaxiFix Tip provides practical information of real fix of a specific vehicle repair issue with detailed descriptions. It is combined with proven fix and vehicle specific data, and

filed into an all-in-one information source to provide you with quick and easy repair solutions.

On MaxiFix community you can find Tips or share your own Tip with the community.

➤ **To search for a MaxiFix Tip**

1. Select a Vehicle:
  - a) Click **Select Vehicle** on the Header at the top of the page.
  - b) Select the **year** of the vehicle from the list.
  - c) Select the **make** of the vehicle from the list.
  - d) Select the **model** of the vehicle from the list.
  - e) Select the **submodel** of the vehicle from the list.
  - f) Select the **engine** of the vehicle from the list.

After completing the vehicle selection procedure, the identified vehicle is shown on the Header.

2. Enter a Search Term.

MaxiFix has an exclusive one-stop lookup that helps you find all of MaxiFix resources by one click. Simply enter a search term into the search bar on the Header to begin the search.

3. Proven Results!

The powerful MaxiFix database gives you proven results! The typical MaxiFix Tips combine actual workshop fixes and data which may include:

- a) OBD II Fault Codes description and reference — helps in diagnostic assessment by making clear the nature of an automotive problem so that beginner and advanced technicians can make effective repairs.
- b) Real Fix Tips – provides repair tips from actual shop practices and are presented in an easy to understand Complaint, Cause, Correction format.

If you still can't find the information you want, you can ask the MaxiFix community for help by clicking **Ask** on the Navigation Menu at the bottom of the screen.

*Adopted!*

The **Adopted!** icon that displays at the top right side of a Tip page indicates that the related Tip has been adopted by at least 1 technician in the community. If a tip has helped you to solve a repair problem, you are encouraged to give an Adopted! count to the tip. Each member is allowed to click the "Adopted!" once for a tip, and each click will add 1 count to the total number of "Adopted!" The "Adopted!" count helps you easily identify which tips are really helpful for repairing vehicle issues. You can also post a comment about how the tip has helped you as reference to other members.

# Operations

---

The Navigation Menu is at the bottom of the screen. Selecting the items on the Navigation Menu allows you to switch between the main sections on MaxiFix. These main sections include:

- Home – shows all questions and allows you to specify questions about one or multiple makes.
- Search Fix – allows you to search for information from all available resources on MaxiFix, including: Open Questions, Tips, and Real Fixes, and displays search results.
- Ask – allows you to ask a question in the community.
- My MaxiFix – shows all your posts including Questions and Fixes in the community, and allows you to view your personal profile, select your vehicle preference, and share your tips.
- My Messages – shows a list of message notifications which is relevant to your activities in the Question section.
- **Support** – opens the FAQ page, or a message box for contacting Customer Service by email.

## Home

Home is the first option on the Navigation Menu at the bottom of the screen. Tapping it opens your MaxiFix home page. There is a list of questions posted on the community, and you can scroll down the page to the bottom and view more questions by tapping **View More**. Click on any question and you will be linked to the detailed page in the Ask section.

You can configure your main screen to display questions only related to the vehicle makes you are interested in, by clicking the “Filter” button on the main page of Home, and select the desired vehicle makes. This filter can be canceled anytime by clicking the “Remove All Filters” button, and the default setting will be restored to display questions about all vehicle makes.

## Search Fix Features

Search Fix, the second option on the Navigation Menu at the bottom of the screen, presents search results for the specified vehicle. Search results are listed in various categories:

- All – includes all search results, including related Questions, Tips, and Real Fixes to your search.

- Questions – presents a list of open Question discussed in the community that may be pertinent to your search.
- Tips – presents a list of Tips that directly correlate to your search criteria. Select a Tip from the list to open and review the complete Tip.
- Real Fixes – presents a list of Tips that have been collected from actual shop repair orders and are presented in an easy-to-understand Complaint, Cause, and Correction format.

## Ask

Ask, the third option on the Navigation Menu at the bottom of the screen, allows you to ask a question about a particular vehicle repair issue in the community.

### ➤ To ask a MaxiFix Question

1. Click **Select Vehicle** on the Header to specify the vehicle you are asking about.
2. Click **Ask** on the Navigation Menu at the bottom of the screen to open the Ask page.
3. On the **Ask** page find **Ask for Help**, fill in the following sections to ask a question.

The Ask page has four sections:

- Subject – this is where you enter a brief subject for the question.
- My Question – asks a clear and concise question that you want to ask the community. Be sure to be descriptive and concise when asking your question.
- Problem Description – describes how the vehicle is behaving.
- Repair History – includes any previous diagnostic tests that you performed, including the results of the tests. Also list any parts that were replaced during previous diagnostic work.

Tap **Cancel** to cancel your question and return to the Ask page.

Tap **Submit** to post your question to the community.

Tap **Attach File** to include images or reference files with your question.

You are requested to select one Adopted Answer from all of the responses and then close the question. For details, please refer to [My Messages](#) on page 99.



## My MaxiFix

My MaxiFix, the fourth option on the Navigation Menu at the bottom of the screen, opens your personal MaxiFix page. To access the features on My MaxiFix page you can select from the tabs:

- My Questions – opens a list with links to the opened questions that you have posted to the community.
- My Cases – opens a list with links to the closed questions and tips that you have contributed to the community.
- Marked Posts – opens a list with links to Tips and discussions that you are actively participating in.
- My Profile – allows you to view your Autel account information including: your Autel ID, personal information, MaxiFix score, phone number and register time, and edit your portrait.
- Vehicle Preference –used to set up a list of preferred vehicles. The preferred list allows you to limit the choices that displayed on the **Select Vehicle** list to specific years, and makes. Click **Set Year** or **Set Make** to set your preferred models. The preferred makes will also be displayed in the **Filter** options on the Home page.
- Share a Tip – allows you to share your personal repair experience with the community.

Click **My MaxiFix** on the Navigation Menu at the bottom of the screen, to display all questions and tips that you have contributed to the community.

### *Create a Tip*

A “Tip” is a concise and complete description of the fix for a particular vehicle repair issue.

#### ➤ **To create a new MaxiFix Tip**

1. Select **My MaxiFix** from the Navigation Menu.
2. Select **Select Vehicle** from the Header and enter the identifying attributes of the vehicle you are writing the Tip about.
3. On the My MaxiFix page find **Share a Tip**; click this link to open the **My Tips** page.
4. Enter the Tip subject in the **Subject** field.
5. Compose your Tip in the **Description** field. Include as much information as possible, while keeping the information concise and to the point. A Tip should provide accurate information that is reader-friendly.

Use the **Cancel** button at the right-side bottom of the page to cancel your tip and return to the My MaxiFix page.

Or use the **Submit** button at the right-side bottom of the page to contribute your tip to the community.

Use the **Attach File** button at the left-side bottom of the page to include images or other supporting data with your question.

### *View Profile Information*

You can view your personal profile by clicking on your account ID or “My Profile” in My MaxiFix section or edit portrait where applicable, and visit other community members’ profile by clicking their portrait. Information included in your profile determines how you are presented to the community, and what type of information will be sent to you from the community.

## **My Messages**

My Messages, the fifth option on the Navigation Menu at the bottom of the screen, shows a list of message notification which is relevant to your activities in the Question section. A notification icon will appear on the top-right corner of “My Messages” if there is any new or unread message in the Question section. The number on the notification icon indicates the total number of the new and unread messages. The displayed number will be reduced correspondingly after viewing. The message notification will appear under the following two conditions:

1. Your question or answer is replied by other MaxiFix community members.
2. Your answer is marked as the “Adopted!” by the MaxiFix community member who asked the question.

Tap **My Messages**, select and open the message you want to read from the list. If your problem is solved according to the reply, you should select one Adopted Answer and close the question. If your answer is marked as “Adopted!”, the prompt “Adopted! + 4” will be displayed permanently.

Tap **Clear** to delete all message notifications.

### *Select “Adopted Answers”*

Members are requested to select one Adopted Answer from all of the responses on “My Messages” page before closing a question. The community members who provided the Adopted Answer are rewarded with scores for their contribution.

About Adopted Answer:

- Only one answer can be selected as “Adopted Answer”.
- Answers can only be rated by the MaxiFix member who asked the question.

### *Close a Question*

When a repair question that you've posted to the community is resolved, you are encouraged to write down the case as a way to share a good solution. This will help the other MaxiFix members to find useful information for practical fix.

To close a question, you need to select the question's response message from the message list on **My Messages** page first, then tap **Adopted Answer** and select **Close Question**. Tap the **Cancel** button to cancel your submission and return to My Messages page. It is strongly recommended to share your repair solutions before closing a question. Your question will be converted to a MaxiFix Community Tip after closing.

### *Score Rewarding System*

1. A score of 4 is awarded if your answer is selected as the “Adopted Answer”.
2. A score of 3 is awarded when you close a question.
3. A score of 2 is awarded if your closed question is marked as "Adopted!" by no less than 20 community members.
4. A score of 1 is awarded if your answer is selected as the "Adopted Answer" for a closed question which is marked as "Adopted!" by no less than 20 community members.
5. A score of 1 is awarded to each of the first three respondents.

## **Support**

Support, the last option on the Navigation Menu at the bottom of the screen, opens a page that provides two ways to gain support from MaxiFix:

1. A message form to contact the administrator of MaxiFix.
2. A Frequently Asked Questions (FAQ) link that answers the most frequent questions from MaxiFix community members.

If you wish to contact the administrator of MaxiFix site, please use the contact form. Select **Support** from the Navigation Menu to open the comment window. To allow the administrator to respond to your question or issue, the following information should be provided:

- Your name
- A contact email address
- A contact phone number

# 16 Maintenance and Service

To ensure that the MaxiSys diagnostic tablet performs at its optimum level, we advise that the product maintenance instructions covered in this section is read and followed.

## Maintenance Instructions

---

The following shows how to maintain your devices, together with precautions to take.

- Use a soft cloth and alcohol or a mild window cleaner to clean the touch screen of the tablet.
- Do not use any abrasive cleansers, detergent, or automotive chemicals to the tablet.
- Maintain the devices in dry conditions and keep them within normal operating temperatures.
- Dry your hands before using the tablet. The touch screen of the tablet may not work if the touch screen is moist, or if you tap the touch screen with wet hands.
- Do not store the devices in humid, dusty or dirty areas.
- Check the housing, wiring, and connectors for dirt and damage before and after each use.
- At the end of each work day, wipe the device housing, wiring, and connectors clean with a damp cloth.
- Do not attempt to disassemble your tablet or the VCI unit.
- Do not drop or cause severe impact to the devices.
- Use only authorized battery chargers and accessories. Any malfunction or damage caused by the use of unauthorized battery charger and accessories will void the limited product warranty.
- Ensure that the battery charger does not come in contact with conductive objects.
- Do not use the tablet beside microwave ovens, cordless phones and some medical or scientific instruments to prevent signal interference.

## Troubleshooting Checklist

---

- A. When the tablet does not work properly:
  - Make sure the tablet has been registered online.

- Make sure the system software and diagnostic application software are properly updated.
  - Make sure the tablet is connected to the Internet.
  - Check all cables, connections, and indicators to see if the signal is being received.
- B. When battery life is shorter than usual:
- This may happen when you are in an area with low signal strength. Turn off your device if it is not in use.
- C. When you cannot turn on the tablet:
- Make sure the tablet is connected to a power source or the battery is charged.
- D. When you are unable to charge the tablet:
- Your charger maybe out of order. Contact your nearest dealer.
  - You may be attempting to use the device in an overly hot/cold temperature. Charge the device in a cooler or warmer area.
  - Your device may have not been connected to the charger properly. Check the connector.

---

 **NOTE**

If the problems persist, please contact Autel's technical support personnel or your local selling agent.

---

## About Battery Usage

---

Your tablet is powered by a built-in Lithium-ion Polymer battery. This means that, unlike other forms of battery technology, you can recharge your battery while some charge remains without reducing your tablet's autonomy due to the "battery memory effect" inherent in those technologies.

---

 **DANGER**

The built-in Lithium-ion Polymer battery is factory replaceable only; incorrect replacement or tampering with the battery pack may cause an explosion.

---

- Do not use a damaged battery charger.
- Do not disassemble or open crush, bend or deform, puncture or shred.
- Do not modify or remanufacture, attempt to insert foreign objects into the battery, expose to fire, explosion or another hazard.
- Use only the included charger and USB cables. Failure to use Autel-authorized charger and/or USB cables, may result in device malfunction or failure.

- Use of an unqualified battery or charger may present a risk of fire, explosion, leakage, or another hazard.
- Avoid dropping the tablet. If the tablet is dropped, especially on a hard surface, and the user suspects damage, take it to a service center for inspection.
- The closer you are to your network's wireless router, the longer your tablet usage time because less battery power is consumed for the connection.
- The battery recharging time varies depending on the remaining battery capacity.
- Battery life inevitably shortens over time.
- Since overcharging may shorten battery life, remove the tablet from its charger once it is fully charged. Unplug the charger, once charging is complete.
- Leaving the tablet in hot or cold places, especially inside a car in summer or winter, may reduce the capacity and life of the battery. Always keep the battery within normal temperatures.

## Service Procedures

---

This section introduces information for technical support, repair service, and application for replacement or optional parts.

### Technical Support

If you have any question or problem on the operation of the product, please contact us.

#### AUTEL NORTH AMERICA

- **Phone:** 855-AUTEL-US (855-288-3587) Monday-Friday 9am-6pm EST
- **Website:** [www.autel.com](http://www.autel.com)
- **Email:** [ussupport@autel.com](mailto:ussupport@autel.com)
- **Address:** 175 Central Avenue, Suite 200, Farmingdale, New York, USA 11735

#### AUTEL EUROPE

- **Phone:** 0049 (0) 61032000522
- **Website:** [www.autel.eu](http://www.autel.eu)
- **Email:** [sales.eu@autel.com](mailto:sales.eu@autel.com), [support.eu@autel.com](mailto:support.eu@autel.com)
- **Address:** Robert-Bosch-Strasse 25, 63225, Langen, Germany

#### AUTEL CHINA HQ

- **Phone:** 0086-755-86147779

- **Website:** [www.autel.com](http://www.autel.com)
- **Email:** [support@autel.com](mailto:support@autel.com)
- **Address:** 6th-10th floor, Building B1, Zhiyuan, Xueyuan Road, Xili, Nanshan, Shenzhen, 518055, China.

#### **AUTEL SOUTH AMERICA**

- **Phone:** (+507) 308-7566
- **Website:** [www.autel.com/es](http://www.autel.com/es)
- **Email:** [sales.latin@autel.com](mailto:sales.latin@autel.com), [latsupport@autel.com](mailto:latsupport@autel.com)
- **Address:** Office 103, Building 3845, International Business Park, Veracruz, Panamá Pacífico, Panamá

#### **AUTEL AUSTRALIA**

- **Phone:** 03 9480 2978 / +61 476293327
- **Website:** [www.autel.com.au](http://www.autel.com.au)
- **Email:** [sales@autel.com.au](mailto:sales@autel.com.au)
- **Address:** 155 Islington Street, Melbourne, Collingwood, VIC 3066

For technical assistance in other markets, please contact your local selling agent.

### **Repair Service**

If it becomes necessary to return your device for repair, please download the repair service form from [www.autel.com](http://www.autel.com), and fill in the form. The following information must be included:

- Contact name
- Return address
- Telephone number
- Product name
- Complete description of the problem
- Proof-of-purchase for warranty repairs
- Preferred method of payment for non-warranty repairs

---

#### **NOTE**

For non-warranty repairs, payment can be made with Visa, Master Card, or with approved credit terms.

---

**Send the device to your local agent, or to the below address:**

6th-10th Floor, Building B1, Zhiyuan,

Xueyuan Road, Xili, Nanshan,

Shenzhen, 518055, China

## **Other Services**

You can purchase the optional accessories directly from Autel's authorized tool suppliers, and/or your local distributor or agent.

Your purchase order should include the following information:

- Contact information
- Product or part name
- Item description
- Purchase quantity



# 17 Compliance Information

*FCC Compliance*

*FCC ID: WQ8MAXISYSMY906*

This equipment has been tested and found to comply with the limits for a Class B digital device, pursuant to Part 15 of the FCC Rules. These limits are designed to provide reasonable protection against harmful interference in a residential installation. This equipment generates uses and can radiate radio frequency energy and, if not installed and used in accordance with the instructions, may cause harmful interference to radio communications. However, there is no guarantee that interference will not occur in a particular installation. If this equipment does cause harmful interference to radio or television reception, which can be determined by turning the equipment off and on, the user is encouraged to try to correct the interference by one or more of the following measures:

- Reorient or relocate the receiving antenna.
- Increase the separation between the equipment and receiver.
- Consult the dealer or an experienced radio/TV technician for help.

This device complies with part 15 of the FCC Rules. Operation is subject to the following two conditions:

- (1) This device may not cause harmful interference, and
- (2) this device must accept any interference received, including interference that may cause undesired operation.

Changes or modifications not expressly approved by the party responsible for compliance could void the user's authority to operate the equipment.

**SAR:**

The radiated output power of this device is below the FCC radio frequency exposure limits. Nevertheless, the device should be used in such a manner that the potential for human contact is minimized during normal operation.

The exposure standard for wireless devices employs a unit of measurement known as the Specific Absorption Rate, or SAR. The SAR limit set by the FCC is 1.6 W/Kg. Tests for SAR are conducted using standard operating positions accepted by the FCC with the device transmitting at its highest certified power level in all tested frequency bands. Although the SAR is determined at the highest certified power level, the actual SAR

level of the device while operating can be well below the maximum value. This is because the device is designed to operate at multiple power levels so as to use only the power required to reach the network. To avoid the possibility of exceeding the FCC radio frequency exposure limits, human proximity to antenna should be minimized.

# 18 Warranty

## 12-Month Limited Warranty

---

Autel Intelligent Technology Corp., Ltd. (the Company) warrants to the original retail purchaser of this MaxiSys Diagnostic Device that should this product or any part thereof during normal usage and under normal conditions be proven defective in material or workmanship that results in product failure within twelve (12) months period from the date of purchase, such defect(s) will be repaired, or replaced (with new or rebuilt parts) with Proof of Purchase, at the Company's option, without charge for parts or labor directly related to the defect(s).

The Company shall not be liable for any incidental or consequential damages arising from the use, misuse, or mounting of the device. Some states do not allow limitation on how long an implied warranty lasts, so the above limitations may not apply to you.

*This warranty does not apply to:*

- a) Products subjected to abnormal use or conditions, accident, mishandling, neglect, unauthorized alteration, misuse, improper installation or repair or improper storage;
- b) Products whose mechanical serial number or electronic serial number has been removed, altered or defaced;
- c) Damage from exposure to excessive temperatures or extreme environmental conditions;
- d) Damage resulting from connection to, or use of any accessory or other product not approved or authorized by the Company;
- e) Defects in appearance, cosmetic, decorative or structural items such as framing and non-operative parts.
- f) Products damaged from external causes such as fire, dirt, sand, battery leakage, blown fuse, theft or improper usage of any electrical source.

---

### **!** IMPORTANT

All contents of the product may be deleted during the process of repair. You should create a back-up copy of any contents of your product before delivering the product for warranty service.

---