

Trademarks

Autel®, MaxiIM®, MaxiCOM®, MaxiDAS®, MaxiScan®, MaxiTPMS®, MaxiRecorder®, and MaxiCheck® are trademarks of Autel Intelligent Technology Corp., Ltd., registered in China, the United States, and other countries. All other marks are trademarks or registered trademarks of their respective holders.

Copyright Information

No part of this manual may be reproduced, stored in a retrieval system or transmitted, in any form or by any means, electronic, mechanical, photocopying, recording, or otherwise without the prior written permission of Autel.

Disclaimer of Warranties and Limitation of Liabilities

All information, specifications and illustrations in this manual are based on the latest information available at the time of printing.

Autel reserves the right to make changes at any time without notice. While information of this manual has been carefully checked for accuracy, no guarantee is given for the completeness and correctness of the contents, including but not limited to the product specifications, functions, and illustrations.

Autel will not be liable for any direct, special, incidental, indirect damages or any economic consequential damages (including the loss of profits).

IMPORTANT

Before operating or maintaining this unit, please read this manual carefully, paying extra attention to the safety warnings and precautions.

For Services and Support

pro.autel.com



www.autel.com

1-855-288-3587 (North America)



+86 (0755) 8614-7779 (China)



support@autel.com

For technical assistance in all other markets, please contact your local selling agent.

Safety Information

For your own safety and the safety of others, and to prevent damage to the device and vehicles upon which it is used, it is important that the safety instructions presented throughout this manual be read and understood by all persons operating or coming into contact with the device.

There are various procedures, techniques, tools, and parts for servicing vehicles, as well as in the skill of the person doing the work. Because of the vast number of test applications and variations in the products that can be tested with this equipment, we cannot possibly anticipate or provide advice or safety messages to cover every circumstance. It is the automotive technician's responsibility to be knowledgeable of the system being tested. It is crucial to use proper service methods and test procedures. It is essential to perform tests in an appropriate and acceptable manner that does not endanger your safety, the safety of others in the work area, the device being used, or the vehicle being tested.

Before using the device, always refer to and follow the safety messages and applicable test procedures provided by the manufacturer of the vehicle or equipment being tested. Use the device only as described in this manual. Read, understand, and follow all safety messages and instructions in this manual.

Safety Messages

Safety messages are provided to help prevent personal injury and equipment damage. All safety messages are introduced by a signal word indicating the hazard level.

DANGER

Indicates an imminently hazardous situation which, if not avoided, will result in death or serious injury to the operator or to bystanders.

WARNING

Indicates a potentially hazardous situation which, if not avoided, could result in death or serious injury to the operator or to bystanders.

Safety Instructions

The safety messages herein cover situations Autel is aware of. Autel cannot know, evaluate or advise you as to all of the possible hazards. You must be certain that any condition or service procedure encountered does not jeopardize your personal safety.

DANGER

When an engine is operating, keep the service area **WELL VENTILATED** or attach a building exhaust removal system to the engine exhaust system. Engines produce carbon

monoxide, an odorless, poisonous gas that causes slower reaction time and can lead to serious personal injury or loss of life.

SAFETY WARNINGS

- Always perform automotive testing in a safe environment.
- Wear safety eye protection that meets ANSI standards.
- Keep clothing, hair, hands, tools, test equipment, etc. away from all moving or hot engine parts.
- Operate the vehicle in a well-ventilated work area, for exhaust gases are poisonous.
- Put the transmission in PARK (for automatic transmission) or NEUTRAL (for manual transmission) and make sure the parking brake is engaged.
- Put blocks in front of the drive wheels and never leave the vehicle unattended while testing.
- Be extra cautious when working around the ignition coil, distributor cap, ignition wires and spark plugs. These components create hazardous voltages when the engine is running.
- Keep a fire extinguisher suitable for gasoline, chemical, and electrical fires nearby.
- Do not connect or disconnect any test equipment while the ignition is on or the engine is running.
- Keep the test equipment dry, clean, free from oil, water or grease. Use a mild detergent on a clean cloth to clean the outside of the equipment as necessary.
- Do not drive the vehicle and operate the test equipment at the same time. Any distraction may cause an accident.
- Refer to the service manual for the vehicle being serviced and adhere to all diagnostic procedures and precautions. Failure to do so may result in personal injury or damage to the test equipment.
- To avoid damaging the test equipment or generating false data, make sure the vehicle battery is fully charged and the connection to the vehicle DLC is clean and secure.
- Do not place the test equipment on the distributor of the vehicle. Strong electromagnetic interference can damage the equipment.

CONTENTS

1. USING THIS MANUAL	1
CONVENTIONS.....	1
2. GENERAL INTRODUCTION	3
MAXIIM SYSTEM TABLET.....	3
MAXIFLASH JVCI+ — VEHICLE COMMUNICATION INTERFACE.....	7
XP400 PRO.....	10
ACCESSORIES KIT.....	13
3. GETTING STARTED	17
POWERING UP.....	17
POWERING DOWN.....	21
4. IMMO	23
ESTABLISH VEHICLE COMMUNICATION.....	23
GETTING STARTED.....	27
VEHICLE IDENTIFICATION.....	29
NAVIGATION.....	32
IMMO.....	35
5. PROGRAMMER	43
OPERATIONS.....	43
6. DIAGNOSTICS	47
DIAGNOSIS.....	47
GENERIC OBDII OPERATIONS.....	61
EXITING DIAGNOSTICS.....	64
7. SERVICE	66
OIL RESET.....	66
ELECTRONIC PARKING BRAKE (EPB).....	67
BATTERY MANAGEMENT SYSTEM (BMS).....	67
STEERING ANGLE SENSOR (SAS) SERVICE.....	68
TIRE PRESSURE MONITORING SYSTEM (TPMS).....	69
8. UPDATE	70
9. SETTINGS	72
UNIT.....	72
LANGUAGE.....	73

PRINTING SETTINGS.....	73
SCAN REPORT	75
PUSH NOTIFICATIONS.....	76
AUTO UPDATE.....	77
VEHICLE LIST	78
SYSTEM SETTINGS.....	78
ABOUT.....	79
10. REMOTE DESKTOP	80
11. DATA MANAGER	82
VEHICLE HISTORY.....	83
WORKSHOP INFORMATION	85
CUSTOMER	86
IMAGE	88
REPORT.....	89
PDF FILES.....	90
REVIEW DATA	90
DATA LOGGING.....	91
APPS UNINSTALL	91
12. SUPPORT	92
PRODUCT REGISTRATION	92
SUPPORT SCREEN LAYOUT.....	94
13. VCI MANAGER	96
14. QUICK LINK.....	97
15. USER FEEDBACK.....	98
16. OEM AUTHORIZATION	99
17. MAXIVIEWER.....	100
18. MAXIVIDEO.....	102
19. MAXISCOPE	103
SAFETY INFORMATION	103
GLOSSORY	105
MAXISCOPE MODULE.....	107
SCREEN LAYOUT AND OPERATIONS	110
TROUBLESHOOTING	118
MAXISCOPE FIRMWARE UPDATE.....	119
20. MAINTENANCE AND SERVICE.....	120

MAINTENANCE INSTRUCTIONS	120
TROUBLESHOOTING CHECKLIST	120
ABOUT BATTERY USAGE	121
21. COMPLIANCE INFORMATION	123
22. WARRANTY	125
LIMITED ONE YEAR WARRANTY.....	125

Autel

1. Using this Manual

This manual contains device usage instructions.

Some illustrations shown in this manual may contain modules and optional equipment that are not included in your system.

Conventions

The following conventions are used.

Bold Text

Bold text is used to highlight selectable items such as buttons and menu options.

Example:

- Tap **OK**.

Notes and Important Messages

Notes

A **NOTE** provides helpful information such as additional explanations, tips, and comments.

Example:

NOTE

The images and illustrations depicted in this manual may differ from the actual ones.

Important

IMPORTANT indicates a situation which, if not avoided, may result in damage to the tablet or vehicle.

Example:

IMPORTANT

Always reset the engine oil life to 100% after every oil change.

Hyperlink

Hyperlinks, or links, that take you to other related articles, procedures, and illustrations are available in electronic documents. Blue italic text indicates a selectable hyperlink and blue underlined text indicates a website link or an email address link.

Illustrations

Illustrations used in this manual are samples, the actual testing screen may vary for each vehicle being tested. Observe the menu titles and on-screen instructions to make correct option selection.

Procedures

An arrow icon indicates a procedure. For example:

- **To power down the tablet**
 1. Long press the **Power/Lock** Button.
 2. Tap **Power off** option.
 3. Tap **OK**, the tablet will turn off in a few seconds.

2. General Introduction

The MaxiIM IM608 II/MaxiIM IM608 Pro II (hereinafter referred to as IM608 II/IM608 Pro II) is the most advanced and smart key programming tool that combines the most powerful IMMO and programming functions with OE-level diagnostics and advanced service functions in one Android based 10.1-inch touchscreen tablet.

With the included key programmer XP400 Pro and MaxiFlash JVCI+, IM608 II/ IM608 Pro II is destined to be the unprecedented key programming tool that you ever wanted.

There are three main components of the MaxiIM system:

- MaxiIM System Tablet — the central processor and monitor for the system.
- MaxiFlash JVCI+ — the device for accessing vehicle data.
- XP400 Pro — the programmer for performing programming function.

This manual describes the construction and operation of the device and how it works to deliver key programming and diagnostic solutions.

MaxiIM System Tablet

Function Description

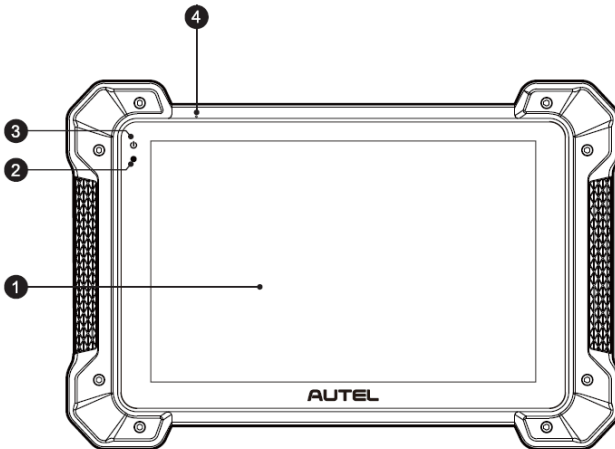

Figure 2-1 MaxiIM Tablet, Front View

1. 10.1-inch LCD Capacitive Touchscreen
2. Ambient Light Sensor — detects ambient brightness.
3. Power LED — indicates battery level & charging or system status.
4. Microphone

The power LED displays green, yellow or red depending on power level and operating state.

A. Green

- Illuminates green when the tablet is charging and the battery level is above 90%.
- Illuminates green when the tablet is powered on and the battery level is above 15%.

B. Yellow

- Illuminates yellow when the tablet is charging and the battery level is below 90%.

C. Red

- Illuminates red when the tablet is powered on and the battery level is below 15%.

5. Collapsible Stand — extends from the back to allow hands-free viewing of the tablet.

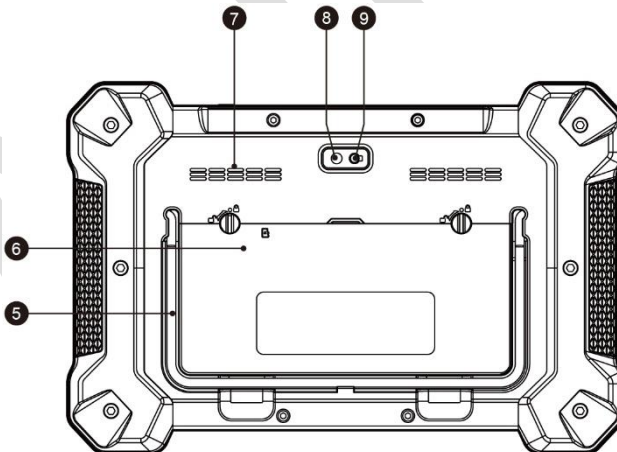

Figure 2-2 MaxilM Tablet, Back View

6. Built-in Battery
7. Loudspeaker
8. Camera Lens
9. Camera Flash

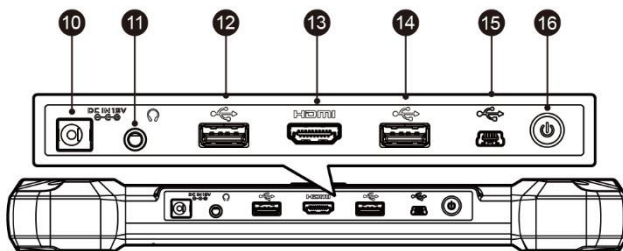

Figure 2-3 MaxilM Tablet, Top View

10. DC Power Supply Input Port
11. Headphone Jack
12. USB Port
13. HDMI (high-definition multimedia interface) Port
14. USB Port
15. Mini USB Port
16. Power/Lock Button — turns the device on & off with long press, or locks the screen with short press.

Power Sources

The tablet can receive power from any of the following sources:

- Internal Battery Pack
- External Power Supply

Internal Battery Pack

The tablet can be powered with its internal rechargeable battery, which if fully charged can provide sufficient power for about 4.5 hours of continuous operation.

External Power Supply

The tablet can be powered from a wall socket using the AC/DC power adapter. The AC/DC power supply also charges the internal battery pack.

Technical Specifications

Table 2-1 Specifications

Item	Description
Operating System	Android™ 10
Processor	Qualcomm Longevity Platform: SDM660/SDA660 2.2 GHz Quad high-performance Kryo cores, 1.9 GHz Quad low-power Kryo cores
Memory	4 GB RAM + 128 GB On-board Memory
Display	10.1-inch LED capacitive touch screen with 1920 x 1200 resolution
Connectivity	Wi-Fi (802.11 a/b/g/n/ac) USB: 2.0 BT v.2.1 + EDR SD Card (Supports up to 32GB) HDMI
Camera (rear)	8.0 Megapixel, AF with Flashlight
Sensors	<ul style="list-style-type: none"> ● Gravity Accelerometer ● Ambient Light Sensor (ALS)
Audio Input/Output	Microphone Dual Speakers 3-Band 3.5 mm stereo/standard headset jack
Power and Battery	15000 mAh 3.8 V lithium-polymer battery Charging via 12 V AC/DC power supply with the temperature between 0°C and 45°C
Input Voltage	12 V (9-24 V)
Power Consumption	6.5 W
Operating Temp.	0 to 50 °C (32 to 122 °F)
Storage Temp.	-20 to 60 °C (-4 to 140 °F)
Dimensions (W x H x D)	300 mm (11.81") x 220 mm (8.66") x 50 mm (1.97")
Net Weight	1.58 kg (3.48 lbs.)

Item	Description
Protocols	ISO 9142-2, ISO 14230-2, ISO 15765-4, K/L-Line, Flashing Code, SAE-J1850 VPW, SAE-J1850 PWM, CAN ISO 11898, Highspeed, Middlespeed, Lowspeed and Singlewire CAN, GM UART, UART Echo Byte Protocol, Honda Diag-H Protocol, TP 2.0, TP 1.6, SAE J1939, SAE J1708, Fault-Tolerant CAN

MaxiFlash JVCI+ — Vehicle Communication Interface

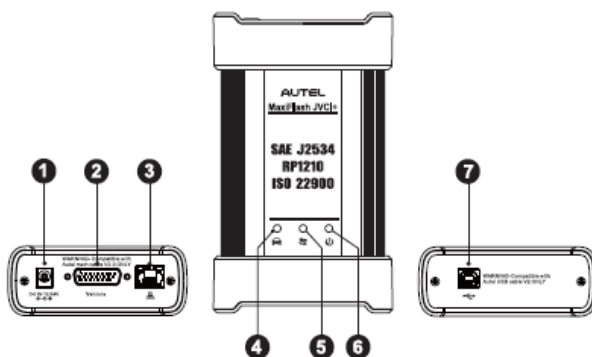

Figure 2-4 MaxiFlash JVCI+ Views

Function Description

1. DC Power Supply Input Port
2. Vehicle Data Connector
3. Ethernet Port
4. Vehicle LED
5. Connection LED
6. Power LED
7. USB Port

Table 2-2 LED Status

LED	Color	Description
Vehicle	Green	Flashes solid green when communicating with the vehicle's system.
Connection	Green	Illuminates solid green when properly connected with the tablet via the USB cable.
	Blue	Illuminates solid blue when connected with the tablet via wireless (BT) connection.
Power	Green	Illuminates solid green when powered on.
	Red	<ul style="list-style-type: none">• Illuminates solid red when a system failure occurs.• Flashes solid red when VCI is upgrading.
	Yellow	Illuminates solid yellow automatically every time when the device is powered on, which is a normal self-test procedure.

! IMPORTANT

Do not disconnect the programming device while the vehicle LED status light is on! If the MaxiFlash JVCI+ programming procedure is interrupted while the vehicle's ECU is blank or only partially programmed, the module may be unrecoverable.

Programming Capability

The MaxiFlash JVCI+ device is a D-PDU, SAE J2534 & RP1210 compliant PassThru programming interface device. Using the updated OEM software, it is capable of replacing the existing software/firmware in the Electronic Control Units (ECU), programming new ECUs and fixing software-controlled drivability issues and emission issues.

Communication Capability

The MaxiFlash JVCI+ device supports Bluetooth (BT) and USB communications. It can transmit vehicle data to the tablet with or without a cable connection. In open areas, the working range of the transmitter through BT communication is up to 328 feet (about 100 m). If the signal is lost due to being taken out of range, communication will be restored once the tablet is within range.

Power Sources

The MaxiFlash JVCI+ device can receive power from the following sources:

- Vehicle Power
- AC/DC Power Supply

Vehicle Power

The MaxiFlash JVCI+ device operates on 12/24 Volts vehicle power, which receives power via the vehicle data connection port. The device powers on whenever it is connected to an OBDII/EOBD compliant data link connector (DLC). For non OBDII/EOBD compliant vehicles, the device can be powered from an auxiliary power outlet adapter or other suitable power port on the test vehicle using the auxiliary power cable.

AC/DC Power Supply

The MaxiFlash JVCI+ device can be powered from a wall socket using the AC/DC power adapter.

Technical Specifications

Table 2-3 Specifications

Name	Value
Communications	<ul style="list-style-type: none">● Wireless BT V2.1 + EDR● USB 2.0● Ethernet
Wireless Frequency	5 GHz
Input Voltage Range	12 VDC to 24 VDC
Supply Current	<ul style="list-style-type: none">● 170 mA @ 12 VDC● 100 mA @ 24 VDC
Operating Temperature	0 to 50 °C (32 to 122 °F)
Storage Temperature	-20 to 60 °C (-4 to 140 °F)
Dimensions (L x W x H)	149 mm (5.87") x 86mm (3.38") x 35 mm (1.28")
Weight	0.29 kg (0.64 lb.)

XP400 Pro

The XP400 Pro has the following functions:

- (1) Read transponder data (including infrared smart key), and generate exclusive keys.
- (2) Read/write on-board EEPROM chip data, and read/write MCU/ECU chip data.
- (3) Read/write remote control transponder data and detect key frequency.

Compatible with the key Programming diagnostic tablet or a computer with installed key Programming software, the XP400 Pro can read/write transponder data quickly and accurately.

Function Description

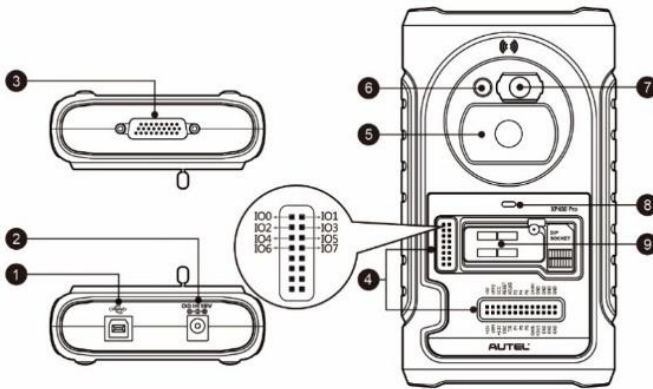

Figure 2-5 XP400 Pro Views

1. USB Port — provides data communication and 5 VDC power supply.
2. DC Port — provides 12 VDC power supply to the XP400 Pro.
3. DB 26-Pin Port — connects with the infrared collector, ECU cable, MCU cable and MC9S12 cable.
4. Cross Signal Pins — holds the MCU spare cable or DIY signal interface to read or write MCU and ECU chips.
5. Vehicle Key Slot — holds the vehicle key.
6. Transponder Slot — holds the transponder.
7. Infrared Key Slot — holds the infrared key.

8. Status LED — indicates the current operating status.
9. EEPROM Component Transponder Slot — holds the EEPROM plug-in transponder or EEPROM socket.

Table 2-4 Definitions of ECU Cable

No.	Color	Definition	Note
1	Red	+12V	
2	Black	GND	
3	Green	IGN	
4	Orange	CANL	
5	Blue	CANH	
6	Brown	BOOTM	
7	Yellow	K	
8	White	LIN	

Table 2-5 Definitions of MCU Cable

No.	Color	Definition	Note
1	Red and White	VPP1	
2	Red and Black	VPP2	
3	Red and Yellow	+12V	
4	Red and Blue	VPPR	
5	Black	GND	
6	Green and White	S0	
7	White	S1	
8	Brown	S2	
9	Gray	S3	
10	Blue	S4	
11	Red	S5	
12	Orange	S6	

No.	Color	Definition	Note
13	Purple	S7	
14	Yellow	S8	
15	Green	S9	
16	Black	GND	Shielded Twisted
17	White	OSC	Shielded Twisted

Table 2-6 Definitions of MC9S12 Cable

No.	Color	Definition	Note
1	Red	+5V	
2	Black	GND	
3	Green	XCLKS	
4	Blue	T/R	
5	Yellow	RESET	
6	Black	GND	Shielded Twisted
7	White	OSC	Shielded Twisted

Table 2-7 Description of the Status LED

Indicator	Status	Description
On	Light Green	Powered on and default
	Flash Green	Communication
	Light Red	Error

Technical Specifications

Table 2-8 Specifications

Item	Description
Operating Temperature	-10 °C to 70 °C (14 °F to 158 °F)
Storage Temperature	-20 °C to 85 °C (-4 °F to 185 °F)
Port	Type B-USB, DB26, DC12
Input Voltage	5 VDC, 12 VDC
Operating Current	< 500 mA
Maximum Consumption	2.5 W
Device Dimensions (L x W x H)	168 mm (8.61") x 98 mm (3.86") x 30 mm (1.81")
Net Weight	520 g (1.15 lbs.)

Accessories Kit

Main Cable

The Main Cable V2.0 connects the MaxiFlash JVCI+ to the vehicle's data link connector (DLC).

NOTE

The MaxiFlash JVCI+ can be connected by the Autel Main Cable V2.0 only. DO NOT use other Autel main cables to connect the the MaxiFlash JVCI+.

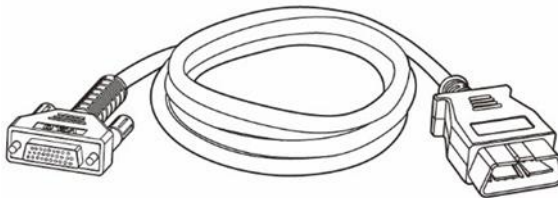

Figure 2-6 Main Cable V2.0 — 1.5m in Length

Other Included Accessories



USB 2.0 Cable V2



Mini USB Cable

Connects the tablet to the PC.



AC/DC Adapter (12 V)



Spare Fuse

6 x 30 mm (2 pcs)



Auxiliary Power Outlet Adapter



AAC001



APC101 (USB Cable)

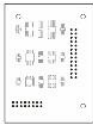

APB129

EEPROM Adapter



APB125

Infrared Collector

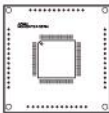

APB104

MCU_FQFP64

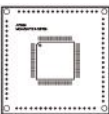

APB105

MCU_FQFP80

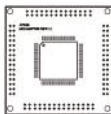

APB106
MCU_FQFP112

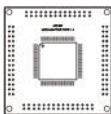

APB107
MCU_FQFP114

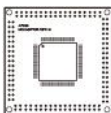

APB108
MCU_FQFP176



APA002
EEPROM Socket



APA101
Signal Cable



APA103
EEPROM Clamp



APA107
ECU Cable



APA108
MCU Cable



APA109
MC9S12 Cable



Connect Cable



APB113
PCF79XX Adapter (Optional)



APB114
EWS3 Adapter (Optional)



APB115
NEC Adapter Plate (Optional)



APB118
NEC Steering Lock Adapter (Optional)



APB119
TB28FXXX Adapter (Optional)

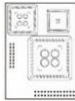

APB120
TMS370 Adapter (Optional)



APB121
AM29FXXX Adapter Plate (Optional)



APB122
AM29FXXX Adapter 1 (Optional)



APB123
AM29FXXX Adapter 2 (Optional)



APB126
M35080&D80 Adapter (Optional)



APB127
MC68HC(7)05BXX Adapter (Optional)

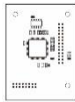

APB128
MC68HC05X32 Adapter (Optional)

NOTE

Optional Accessories can be purchased separately.

3. Getting Started

Ensure the tablet is sufficiently charged or is connected to the external power supply (see [Power Sources](#)).

NOTE

The images and illustrations depicted in this manual may differ from the actual ones.

Powering Up

Long press the **Power/Lock** button on the top right of the tablet to power on the unit. The power LED light will illuminate green. The system boots up, and displays the lock screen. Slide to enter the MaxiIM Job Menu.

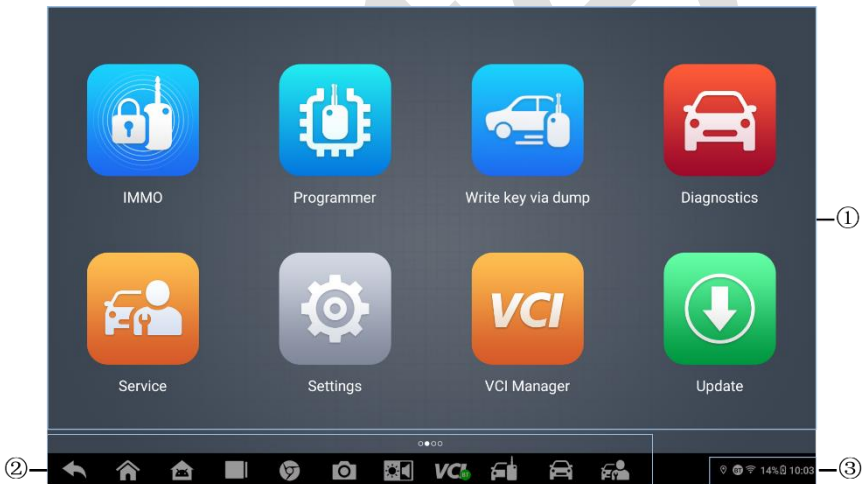

Figure 3-1 *MaxiIM Job Menu*

1. Application Buttons
2. Locator and Navigation Buttons
3. Status Icons

NOTE









The tablet screen is locked by default when first powered on. It is recommended to lock the screen to protect the information in the system and reduce the power consumption.







The touch screen navigation is menu-driven enabling quick access to functions and features by tapping on options headings and answering dialog windows. Detailed descriptions of the menu structures are found in the application chapters.

Application Buttons

Descriptions of the tool applications are displayed in the table below.

Table 3-1 Applications













Button	Name	Description
	IMMO	Accesses IMMO functions menu. See IMMO for details.
	Programmer	Accesses Programming functions menu. See Programmer for details.
	Diagnostics	Accesses diagnostic functions menu. See Diagnostics for details.
	Service	Accesses special functions menu. See Service for details.
	Update	Checks for the latest update available for the MaxiIM system, and performs updates. See Update for details.
	Settings	Accesses MaxiIM system settings menu and general tablet menu. See Settings for details.
	Remote Desktop	Configures the unit to receive remote support using the TeamViewer application program. See Remote Desktop for details.
	Data Manager	Accesses the organization system for saved data files. See Data Manager for details.
	Support	Synchronizes Autel's online service database with the MaxiIM tablet. See Support for details.
	VCI Manager	Establishes and manages BT connection with the MaxiFlash. See VCI Manager for details.

Button	Name	Description
	Quick Link	Provides associated website bookmarks to allow quick access to product update, service, support, and other information. See Quick Link for details.
	User Feedback	Allows you to submit problem feedbacks related to this tablet. See User Feedback for details.
	OEM Authorization	Provides an authorization to unlock safety gateway of some vehicle models. See OEM Authorization for details.
	MaxiViewer	Provides a quick search for supported functions and/or vehicles. See MaxiViewer for details.
	MaxiVideo	Configures the unit to operate as a video scope device by connecting to an imager head cable for close vehicle inspections. See MaxiVideo for details.
	MaxiScope	Configures the unit to operate as an automotive oscilloscope to perform electrical and electronic circuit tests and monitor signal activities. See MaxiScope for details.
	Autel User Center	Allows you to register an account, view and edit your personal profile, and link your device.

Locator and Navigation Buttons

Operations of the Navigation buttons at the bottom of the screen are described in the table below:

Table 3-2 Locator and Navigation Buttons

Button	Name	Description
	Locator	Indicates the location of the screen. Swipe the screen left or right to view the previous or next screen.
	Back	Returns to the previous screen.
	MaxiIM Home	Enters to MaxiIM Job Menu.
	Android Home	Enters Android System's Home screen.
	Recent Apps	Displays a list of applications that are currently in use. Tap an app icon to launch. To remove an app, swipe it to the left or right.
	Chrome	Launches the Android built-in browser.
	Camera	Tap icon to open camera viewfinder. Press and hold icon to capture screenshot of display screen. The saved files are auto-stored in the Data Manager application for later review.
	Display & Volume	Adjust the brightness and volume of the tool.
	VCI	Opens the VCI Manager application. The green badge at the bottom-right corner indicates the tablet is communicating with the VCI, otherwise a red cross icon displays.
	IMMO Shortcut	Enters to the IMMO screen.
	Diagnostics Shortcut	Enters to the Diagnostics screen.
	Service Shortcut	Enters to the Service screen.

System Status Icons









As the tablet is working with the Android operating system, you may refer to Android documents for more information.

By sliding down from the top of the screen or tapping the bottom-right corner, a Shortcuts Panel will be displayed, on which you are allowed to set various system settings of the tablet. Operations of each button on the panel are described in the table below:

NOTE

The shortcuts buttons will be highlighted when enabled and dimmed when disabled.

Table 3-3 Shortcuts Panel Buttons

Button	Name	Description
	Wi-Fi	Enables/disables Wi-Fi when pressed.
	Bluetooth	Enables/disables Bluetooth when pressed.
	Battery	Shows the battery status.
	Do Not Disturb	Enables/disables Do Not Disturb mode.
	Flashlight	Turns on/off the flashlight when pressed.
	Auto-rotate	Enables/disables auto-rotate screen.
	Airplane Mode	Enables/disables Airplane Mode when pressed.
	Location	Enables/disables location recording function.
	Logger	Accesses the Log Collection screen.

Powering Down

All vehicle communications must be terminated before shutting down the tablet. A warning message displays if you attempt to shut down the tablet when it is communicating with the vehicle. Forcing a shut-down while communicating may lead to ECM problems on some vehicles. Please exit the Diagnostics application before powering down.

➤ **To power down the tablet**

1. Long press the **Power/Lock** Button.
2. Tap **Power off**.
3. Tap **OK**, the tablet will turn off in a few seconds.

Reboot System

In case of a system crash, long press the **Power/Lock** button and tap **Restart** to reboot the system.

Autel

4. IMMO

The IMMO application mainly provides Automatic Selection, Manual Selection, and System Selection modes to guide technicians to perform IMMO-related functions, including Key Learning, Remote Control Learning, Remote Control Add, etc.

Establish Vehicle Communication

The IMMO operations require connecting the IM608 II/IM608 Pro II tablet to the test vehicle through the MaxiFlash JVCI+ using the main cable and the included USB cable (2m). To establish a proper vehicle communication to the tablet, you need to perform the following steps:

1. Connect the MaxiFlash JVCI+ to the vehicle's DLC for both communication and power source.
2. Connect the MaxiFlash JVCI+ to the tablet via BT pairing or USB connection.
3. When the above steps are completed, check the VCI navigation button at the bottom bar on the screen, if a green USB/BT badge displays at the lower-right corner, the IM608 II/IM608 Pro II is ready to start vehicle diagnosis.

Vehicle Connection

The method used to connect the MaxiFlash JVCI+ to a vehicle's DLC depends on the vehicle's configuration as follows:

- A vehicle equipped with an On-board Diagnostics Two (OBDII) management system supplies both communication and 12-volt power through a standardized J-1962 DLC.
- A vehicle not equipped with an OBDII management system supplies communication through a DLC connection, and in some cases supplies 12-volt power through the auxiliary power outlet adapter receptacle or a connection to the vehicle battery.

OBDII Vehicle Connection

This type of connection only requires the main cable without any additional adapter.

➤ **To connect to an OBDII vehicle**

1. Connect the main cable's female adapter to the Vehicle Data Connector on the MaxiFlash JVCI+, and tighten the captive screws.
2. Connect the cable's 16-pin male adapter to the vehicle's DLC, which is generally located under the vehicle dashboard.

NOTE

The vehicle's DLC is not always located under the dashboard; refer to the user manual of the test vehicle for additional connection information.

Non-OBDII Vehicle Connection

This type of connection requires both the main cable and a required OBDI adapter for the specific vehicle being serviced.

There are three possible conditions for Non-OBDII vehicle connection:

- DLC connection supplies both communication and power.
- DLC connection supplies communication and power is to be supplied via the auxiliary power outlet adapter connection.
- DLC connection supplies communication and power is to be supplied via connection to the vehicle battery.

➤ **To connect to a Non-OBDII Vehicle**

1. Connect the main cable's female adapter to the Vehicle Data Connector on the MaxiFlash JVCi+, and tighten the captive screws.
2. Locate the required OBDI adapter and connect its 16-pin jack to the main cable's male adapter.
3. Connect the attached OBDI adapter to the vehicle's DLC.

NOTE

Some adapters may have more than one adapter or may have test leads instead of an adapter. Whatever it has, make the proper connection to the vehicle's DLC as required.

➤ **To connect the auxiliary power outlet adapter**

1. Plug the DC power connector of the auxiliary power outlet adapter into the DC power supply input port on the device.
2. Connect the male connector of the auxiliary power outlet adapter into the vehicle's auxiliary power outlet adapter receptacle.

NOTE

After the MaxiFlash JVCi+ is successfully connected to the vehicle, the Power LED on the device illuminates, and a brief beeping sound will be heard.

VCI Connection

After the VCI is properly connected to the vehicle, the Power LED on the VCI illuminates solid green, and is ready to establish communication with the tablet.

The VCI supports two communication methods with the tablet: BT and USB.

Pairing Up via BT

Among all methods, BT pairing is recommended as the first choice for the communication between the tablet and the VCI. The working range for BT communication is about 328 feet (about 100 m); this means you can perform key programming and vehicle diagnosis freely around the workshop with greater convenience.

If you use more than one VCI to connect to the test vehicles when customers are many, you can perform key programming and vehicle diagnosis on various vehicles conveniently, by pairing the tablet separately to each of the VCI connected to the different test vehicles, via BT, without the need to repeat the plugging and unplugging procedure, which is unavoidable through traditional wired connection, thus saving more time and providing more efficiency.

➤ **To pair up the tablet with the VCI via BT**

1. If not already done, power up the tablet.
2. Select the **VCI Manager** application on the MaxiIM Job Menu.
3. When the **VCI Manager** application is opened, the device automatically starts scanning available VCI devices around for BT pairing. The found devices are listed in the Setting section on the right side of the screen.

NOTE

If no VCI device is found, this may indicate that the signal strength of the transmitter is too weak to be detected. In this case try to get closer to the device, or reposition the VCI device, and remove all possible objects that may cause signal interference. When done, tap the **Scan** button at the top-right corner to start searching again.

4. The VCI device name displays as Maxi suffixed with a serial number. Select the required device for pairing.
5. When pairing is successfully done, the connection status displayed to the right of the device name is shown as Connected.
6. Wait for a few seconds, and the VCI button on the system Navigation bar at the bottom of the screen shall display a green BT, indicating the tablet is connected to the VCI, and is ready to perform vehicle diagnosis.

USB Cable Connection

The USB cable connection is a simple and quick way to establish communication between the tablet and the VCI. After properly connecting the USB cable from the tablet to the VCI, the VCI navigation button at the bottom bar of the screen shows a green USB badge in a few seconds, and the USB LED on the VCI illuminates solid green, indicating the connection between the devices is successful.

The MaxiIM tablet is now ready to perform key programming and vehicle diagnosis.

No Communication Message

- A. If the tablet is not connected to the VCI, an “Error” message displays. An “Error” message indicates the tablet is not communicating with the VCI, and so cannot gain access to the vehicle control module. In this case, you need to do the following check-ups:
- Check if the VCI is powered on.
 - In case of wireless connection, check if the network is configured correctly, or if the right device has been connected.
 - During the diagnosis process, if communication is suddenly interrupted due to the loss of signal, check if there are any objects that causes signal interruption.
 - Check if the VCI is properly positioned. It is recommended to put the MaxiFlash with the front side up.
 - Try standing closer to the VCI to obtain more stable signals, and faster communication speed. In case of wired connection, check the cable connection between the tablet and the VCI.
 - Check if the green LED on the VCI is illuminated for BT or USB.
 - Check if the Error LED on the VCI is on, this may indicate there is a communication error between the devices, in this case try re-establishing the connection again; if it does not work, there may be a hardware problem with the device, in this case contact Autel or local distributor for technical support.
- B. If the VCI is unable to establish a communication link, a prompt message displays with check instructions. The following conditions are the possible causes for this message to display:
- The VCI is unable to establish a communication link with the vehicle.
 - You’ve selected a system for testing that the vehicle is not equipped with.
 - There is a loose connection.
 - There is a blown vehicle fuse.
 - There is a wiring fault on the vehicle, or the data cable or adapter.
 - There is a circuit fault in the data cable or adapter.

- Incorrect vehicle identification was entered.

Getting Started

Ensure a communication link is established between the test vehicle and the tablet via the main cable, and the XP400 Pro is connected to the tablet with the supplied USB cable.

Vehicle Menu Layout

When the tablet is properly connected to the vehicle, the platform is ready to start vehicle diagnosis. Tap on the **IMMO** application button on the IM608 II/IM608 Pro II Job Menu to access the Vehicle Menu.













Figure 4-1 Vehicle Menu

1. Top Toolbar Buttons
2. Manufacturer Buttons

Top Toolbar Buttons

The operations of the toolbar buttons at the top of the screen are listed and described in the table below:

Table 4-1 Top Toolbar Buttons

Button	Name	Description
	Home	Returns to the MaxiIM Job Menu.
	VID	Displays a dropdown list; tap Auto Detect for auto VIN detection; tap Manual Input to enter VIN manually; tap Scan VIN/License to scan VIN, Barcode or License.
	All	Displays all the vehicle makes in the vehicle menu.
	Favorites	Displays user-selected favorite vehicle makes.
	History	Displays the stored test vehicle history records. This option provides you direct access to the previously tested vehicle recorded during previous test sessions. See Vehicle History for details.
	America	Displays the American vehicle menu.
	Europe	Displays the European vehicle menu.
	Asia	Displays the Asian vehicle menu.
	China	Displays the Chinese vehicle menu.
	Search	Displays the virtual keyboard to manually enter the specific vehicle make required.
	Cancel	Exits the search screen or cancels an operation.

Manufacturer Buttons

To begin, select the manufacturer button of the test vehicle, followed by the mode selection.

Vehicle Identification

The MaxiIM IMMO system supports five methods for Vehicle Identification.

1. Auto Detect
2. Manual Input
3. Scan VIN/License
4. Automatic Selection
5. Manual Selection

Auto Detect

The MaxiIM IMMO system features the latest VIN-based Auto Detect function to identify vehicles and it is applied to IMMO, Programmer, Diagnostics, and Service applications.

➤ To perform Auto Detect

1. Tap the **IMMO** application button on the MaxiIM Job Menu. The Vehicle Menu displays.



Figure 4-2 Auto VIN Screen

2. Tap the **VID** button on the top toolbar to open a dropdown list.
3. Select **Auto Detect**. Once the test vehicle is successfully identified, the screen will display the vehicle profile. Tap **OK** at the bottom right to confirm the vehicle profile. If the VIN does not match with the test vehicle's VIN, enter VIN manually or tap **Read** to acquire VIN again.
4. Tap **Yes** to confirm the vehicle profile or **No** if the information is not correct.

Manual Input

For vehicles that not supporting the Auto Detect function, you may manually enter the vehicle VIN.

➤ To perform Manual Input

1. Tap the **IMMO** application button on the MaxiIM Job Menu. The Vehicle Menu displays.
2. Tap the **VID** button on the top toolbar.
3. Select **Manual Input**.
4. Tap the input box and enter the correct VIN.

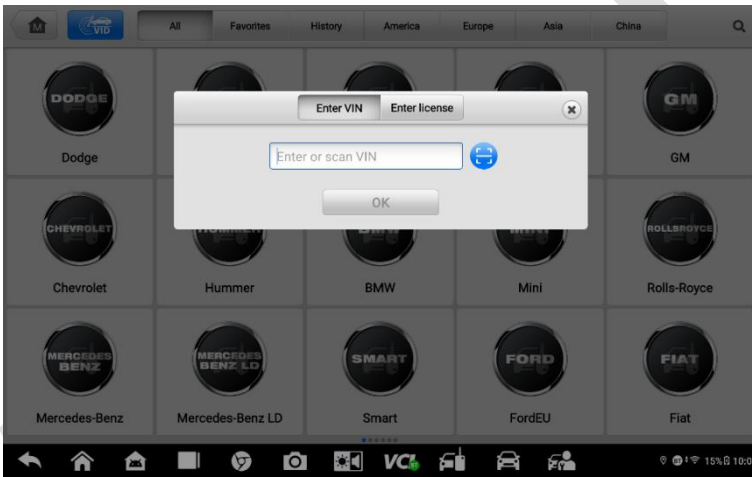

Figure 4-3 Enter VIN Screen

5. Tap **OK** to complete or tap **X** to exit Manual Input.

Scan VIN/License

The **Scan VIN/License** function provides access to identify the test vehicle information by simply scanning VIN, barcode and license plate.

➤ To perform the Scan VIN/License

1. Tap **IMMO** application button on the MaxiIM Job Menu. The Vehicle Menu displays.
2. Tap the **VID** button on the top bar.

3. Tap **Scan VIN/License** to enter scanning screen. On the right side of the screen, from the top to the bottom, three options are available: **Scan Barcode**, **Scan VIN**, and **Scan License**.

NOTE

The method of Scan License is supported in some countries and areas. Please manually enter the license numbers if it is not available.

Select one of three options and position the tablet to align the VIN or license number within the scanning window, the result displays in the Recognition result dialog box after scanned. Tap **OK** to confirm the result, and then the vehicle information confirmation screen will display on the tablet. If all the vehicle information is correct, tap the icon in the middle of the screen to confirm the VIN of the vehicle being tested, tap **OK** to continue.

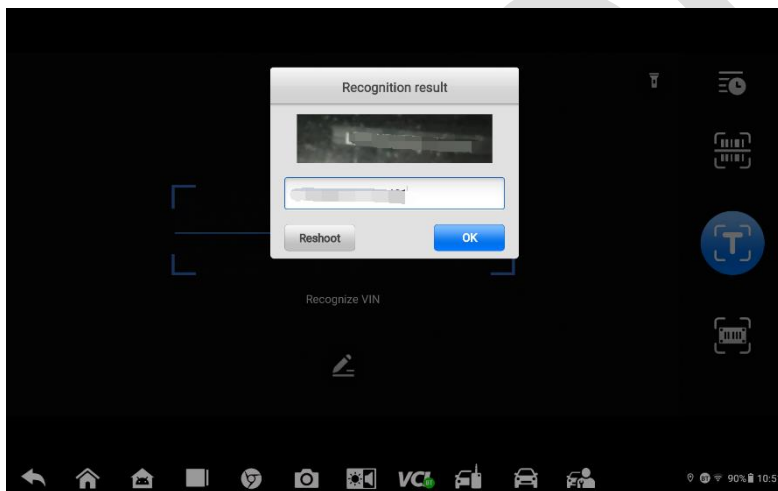

Figure 4-4 Scan VIN Code

If the VIN/License number cannot be scanned, please manually enter the VIN/License number. Tap **OK** to continue. Manually enter the license numbers and select a vehicle brand in the vehicle information confirmation screen. Tap the icon in the middle of the screen to confirm the VIN of the vehicle being tested, tap **OK** to continue.

Automatic Selection

The **Automatic Selection** can be selected after selecting the test vehicle manufacturer.

➤ **To perform Automatic Selection**

1. Tap the **IMMO** application button from the MaxiIM Job Menu. The Vehicle Menu displays.
2. Tap the manufacturer button of the test vehicle.
3. Tap **Automatic Selection** and the VIN information will be automatically acquired. Follow the on-screen instruction to display the function screen.

Manual Selection

When the vehicle's VIN is not automatically retrievable through the vehicle's ECU, or the specific VIN is unknown, the vehicle can be manually selected.

This mode of vehicle selection is menu driven, repeat the first two steps of the automatic selection operation and tap **Manual Selection**. Through a series of on-screen prompts and selections, the test vehicle is chosen. If needed, press the **ESC** button at the bottom-right corner of the screen to return to the previous screen.

Navigation

Navigating the IMMO interface and selecting test are discussed in this section.

IMMO Screen Layout

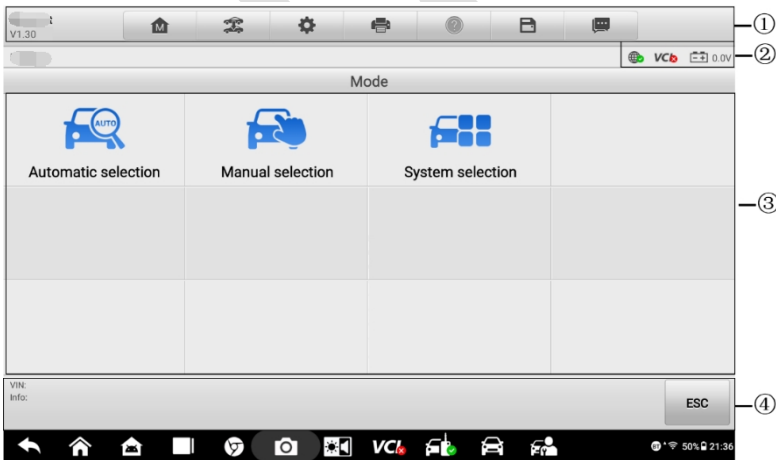

Figure 4-5 Mode Selection Screen







The IMMO screens typically include four sections.

1. Operation Toolbar
2. Status Information Bar
3. Main Section
4. Function Buttons

Operation Toolbar

The Operation Toolbar contains a number of buttons such as print and save. The table below provides a brief description of the operations.

Table 4-2 Operation Toolbar Buttons

Button	Name	Description
	Home	Returns to the MaxiIM Job Menu.
	Vehicle Swap	Exits the function session of the currently identified test vehicle and returns to the vehicle menu screen.
	Settings	Opens the settings screen. See Settings .
	Print	Prints a copy of the displayed data. See Printing Settings for additional information.
	Help	Displays operational instructions or tips.
	Save	<p>Tap this button to open a sub menu which may include 3 options to save data.</p> <ul style="list-style-type: none"> ● Tap Take a Screenshot to save the current screen. ● Tap Save All Data to save a PDF file. ● Tap Save Report to save the data in a report form. <p>All saved data is stored in the Data Manager application for later reviews. See Data Manager Operations.</p>
	Data Logging	Records the communication data and ECU information of the test vehicle. The saved data can be reported and sent to the technical center via the Internet.

Button	Name	Description
		You can go to the Support application to follow up the processing progress, see Data Logging for detailed information.

➤ To print data

1. Tap the **IMMO** application button on the MaxiIM Job Menu. The **Print** button on the toolbar is available throughout the IMMO operations.
2. Tap **Print**. A drop-down menu displays. Tap **Print This Page** to print a screenshot of the current screen or tap **Print All Data** to print the all data.
3. A temporary file will be created and send to the connected computer for printing.
4. When the file is transferred successfully, a confirmation message displays.

➤ To submit Data Logging reports

1. Tap the **IMMO** application button on the MaxiIM Job Menu. The **Data Logging** button on the toolbar is available throughout the IMMO operations.
2. Tap the **Data Logging** button to display error options. Select a specific error and tap **OK**. A submission form will display to let you fill in the report information.
3. Tap the **Send** button to submit the report form via the Internet. A confirmation message displays when the report has been successfully sent.

Status Information Bar

The Status Information Bar at the top of the Main Section displays the following items:

1. **Network Status Icon** — indicates whether a network is connected.
2. **VCI Icon** — indicates the communication status between the tablet and the VCI device.
3. **Battery Icon** — displays the vehicle's voltage status.

Main Section

The Main Section of the screen varies depending on the stage of operations. The Main Section can display vehicle identification selections, the main menu, test data, messages, instructions, and other information.

Function Buttons

The displayed Function Buttons vary depending on the stage of operations. Function buttons can be used to navigate menus, to save or clear data, to exit scanning and to perform a number of other control functions. The use of these buttons will be discussed in detail in the following sections of the corresponding test operations.

Screen Messages

Screen messages appear when additional input is needed before proceeding. There are mainly three types of on-screen messages: Confirmation, Warning, and Error.

Confirmation Messages

This type of messages usually displays as an “Information” screen to inform the user that a selected action cannot be reversed or when an action has been initiated and confirmation is needed to continue.

When a user-response is not required to continue, the message displays briefly.

Warning Messages

This type of messages displays a warning that a selected action may result in an irreversible change or loss of data. An example of this type of message is the “Erase Codes” message.

Error Messages

Error messages display when a system or procedural error has occurred. Examples of possible errors include a disconnection or communication interruption.

Making Selections

The IMMO application is a menu-driven program that presents a series of choices. As a selection is made, the next menu in the series displays. Each selection narrows the focus and leads to the desired test. Tap the screen to make menu selections.

IMMO

The IMMO application requires a data link to the IMMO electronic control system of the test vehicle for diagnosis via OBDII connection. The application retrieves vehicle IMMO information and performs IMMO related functions, including Key Learning, Remote Control Learning, Remote Control Add, etc.

There are three common modes available when accessing the IMMO section:

1. Automatic Selection
2. Manual Selection
3. System Selection

The available modes displayed on the screen may vary from different vehicle brands. After a mode is selected and the tablet establishes communication with the vehicle, the corresponding function menu or selection menu displays.

Automatic Selection

The Automatic Selection provides guided functions with step-by-step instructions. Once the test vehicle is identified, a vehicle profile will display, select **Yes** to continue.

There are mainly four options available on the next screen after the vehicle information is confirmed:

1. IMMO Status Scan
2. Control Unit
3. Hot Function
4. Vehicle IMMO Information

IMMO Status Scan

The IMMO Status Scan function performs a comprehensive scanning over all the systems on the vehicle's IMMO ECU in order to locate fault systems and retrieve DTCs. The sample operation interface of IMMO Status Scan displays as below:

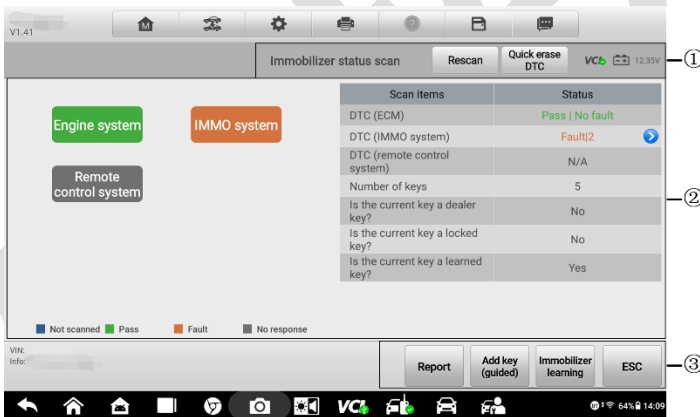

Figure 4-6 IMMO Status Scan Screen

1. Navigation Bar
2. Main Section
3. Function Buttons

Navigation Bar

The Navigation Bar shows the heading of the screen, VCI status and vehicle's voltage status. There are two options available:

- Rescan — tap to scan the IMMO system for DTCs again.
- Quick erase DTC — tap to erase the fault codes.

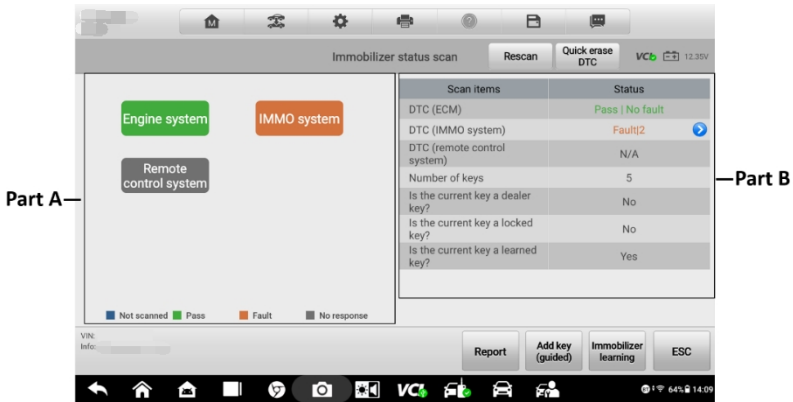

Figure 4-7 Main Section of IMMO Status Screen

Part A displays the scanned systems highlighted by different colors. Each color represents varied status, which you can check on the screen.

Part B displays scan results with the left column showing scan items and the right displaying the diagnostic marks, which indicate different conditions of the test result.

- -!-: indicates that the scanned system may not support the code reading function, or there is a communication error between the tool and the control system.
- -? -: indicates that the vehicle control system has been detected, but the tool cannot accurately locate it.
- Fault | #: indicates there is/are detected fault code(s) present; “#” indicates the number of the detected faults.
- Pass | No Fault: indicates the system has passed the scanning process and no fault has been detected.
- Unknown Status: Indicates the system has not been scanned.
- Not Responded: Indicates the system has not received a response.
- N/A: The system is not selected.
- Unselected System: The system is not selected for testing.
- Selected: The system is selected for testing.

Function Buttons

The Function Buttons are described briefly in the table below.

Button	Description
Report	Displays the diagnostic data in the report form.
Add key(guided)	Enters keys learning program.
Immobilizer learning	Displays Immobilizer learning screen.
ESC	Exits the IMMO Status Scan function.

Control Unit

This option allows you to manually locate a required control system for testing through a series of choices. Simply follow the menu-driven procedure, and make proper selection each time; the program will guide you to the IMMO function after a few choices you have made. The functions vary from IMMO parts, please follow the onscreen instructions to select the correct IMMO part.

Take **Key Learning** as an example.

1. Select **Immobilizer/Smart System** on the Control Unit menu. Select **Key Learning** on the function menu. Continue to select **Key Learning** on the Key Learning menu. The tablet will automatically start to read IMMO data.

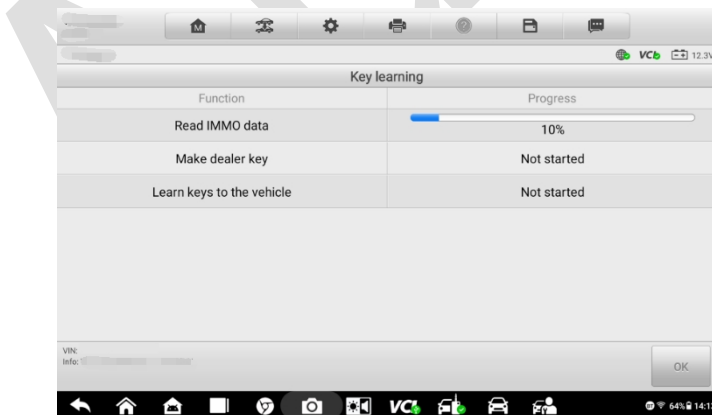

Figure 4-8 Key Learning Screen 1

2. When Read IMMO data completes, the tablet will prompt a “Do you want to generate a dealer key?” message, select **Yes** to confirm, or select **No** to quit the operation.

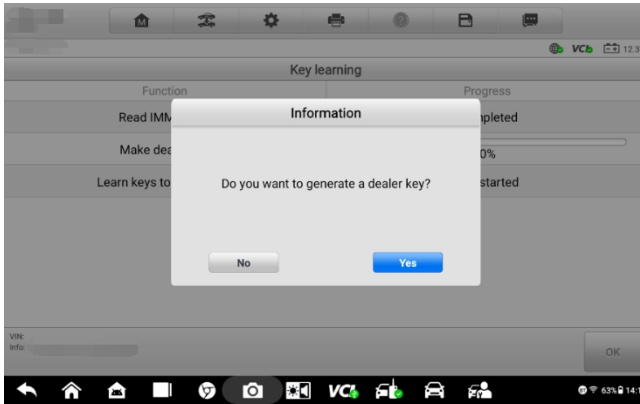

Figure 4-9 Key Learning Screen 2

3. Follow the onscreen instruction to place a Blade Key in the XP400 Pro key slot and press **OK** to continue.
4. If the new key is blocked, the tablet will ask if you want to unlock the key, select **Yes** to continue, or select **No** to quit the operation.
5. A "Make dealer key success!" message displays when the process is completed successfully.
6. Then the tablet will automatically move to the next step, Key adaption to vehicle, and the following message will prompt up.
7. Make selections according to the test vehicle.
8. Input the numbers of the keys to be learned and press **OK** to continue.

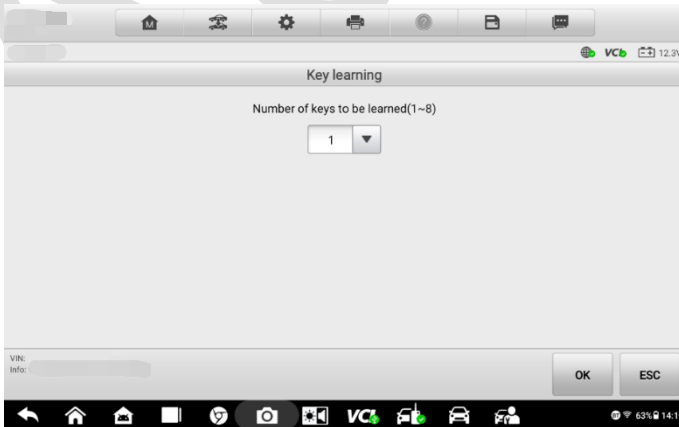

Figure 4-10 Key Learning Screen 3

9. Follow the onscreen instructions to insert the key to be learned into the vehicle ignition switch.

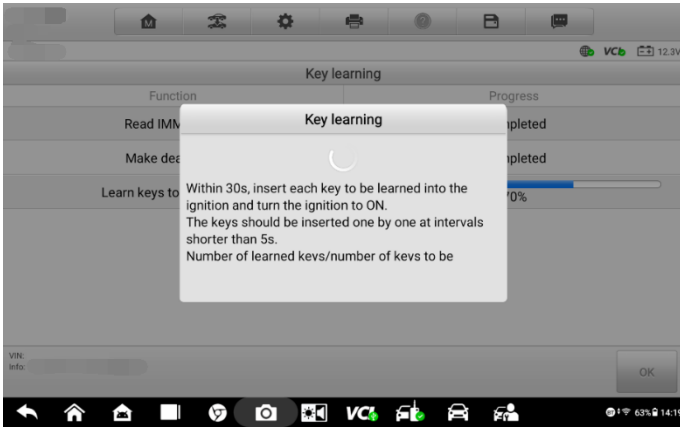

Figure 4-11 Key Learning Screen 4

10. When Key Learning is completed successfully, the following screen displays. Press **OK** to exit the function.

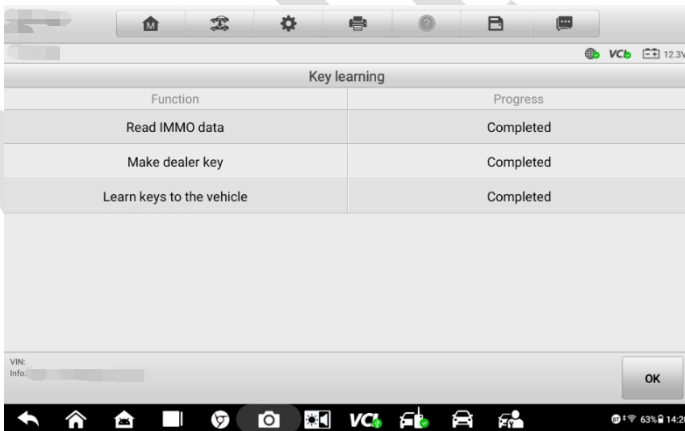

Figure 4-12 Key Learning Screen 5

Hot Function



Figure 4-13 Hot Function Screen

Hot Function consists of guided functions with step-by-step instructions. The available functions may vary from the test vehicle. The function may include Add Key (guided). Follow the corresponding on-screen instructions to complete the operation.

Vehicle IMMO Information

This function displays the specific information of the tested vehicle, including key information, and OBD position.

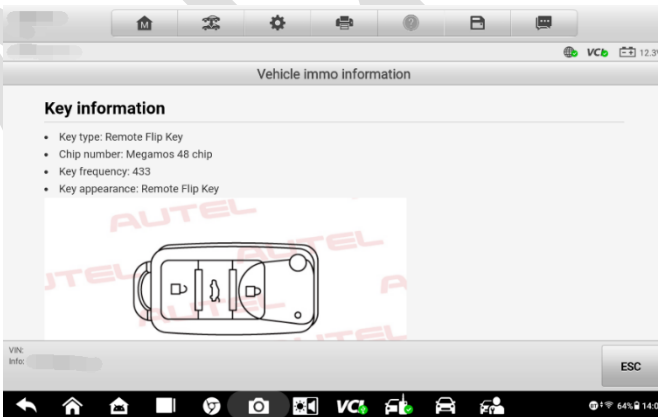

Figure 4-14 Vehicle IMMO Information Screen

Manual Selection

For vehicles that do not support Auto selection by VIN, you may manually select your vehicle information by tapping on Manual Selection. After the vehicle information is selected, a vehicle profile will display. Select **OK** to continue.

➤ To perform Manual Selection

1. Tap **IMMO** application button on the MaxiIM Job Menu.
2. Select the manufacturer button of the test vehicle.
3. Tap **Manual Selection** and select the test vehicle information such as model, year, key type, etc. Select **OK** to confirm the vehicle information. Follow the on-screen instructions to display the function screen.

System Selection

The System Selection provides direct access to vehicles' immobilizer systems. The selections may include Read Immobilizer Password, Keyless System, IMMO module replacement, etc. Follow the on-screen instructions to complete the operation.

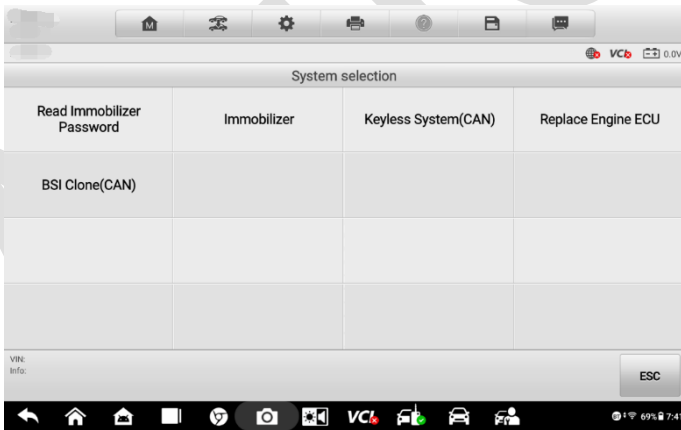

Figure 4-15 System Selection Screen

5. Programmer

The Programmer application requires connection between the tablet and the XP400 Pro, and no vehicle connection is required. This application can access the key chip, read, retrieve, and write key information, as well as other key related functions.

Operations

There are five available options when you access the Programmer application:

1. Key — performs keys reading and writing function, remote detection and view keys information.
2. Chip (EEPROM, MCU, ECU) — performs chip reading and writing function.
3. Universal Key — generates universal keys, detects universal keys information, and adjusts buttons.
4. Write Key via Dump — allows you to generate keys without the vehicle but with the ECU chip.
5. Version Information — checks the version of the programmer.

Select the targeted function and follow the on-screen instructions to complete the operation.

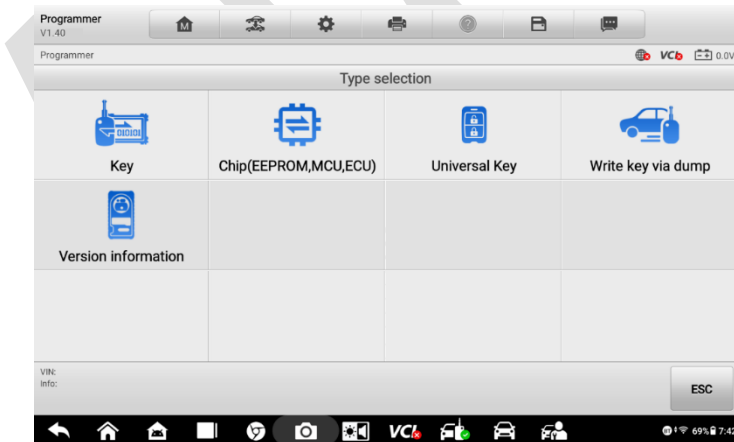

Figure 5-1 *Programmer Function Menu*

Take **Chip Read & Write** as an example:

1. Tap **Programmer** on the MaxiIM Job Menu.
2. Select **Chip (EEPROM, MCU, ECU)** on the Type selection menu.
3. Select Chip Read & Write on the Functions menu.
4. In this example, select **EEPROM** on the following screen.



Figure 5-2 Chip Read & Write Screen

5. The screen displays the types of EEPROM supported. Select the right type.



Figure 5-3 EEPROM Screen

6. Select **Read** on the next menu.



Figure 5-4 Read Menu

7. The chip data screen displays. Select **Save** to save the data, or select **Cancel** to exit.

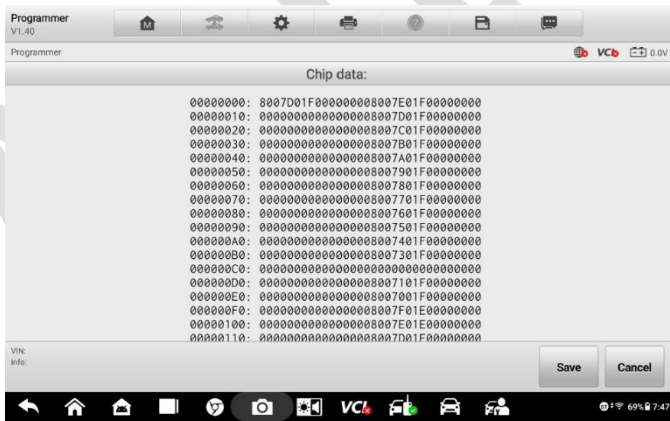

Figure 5-5 Read Operation Screen

8. Type the file name and select **Save**, the chip data will be saved on the tablet. And a “File saved successfully.” message displays.

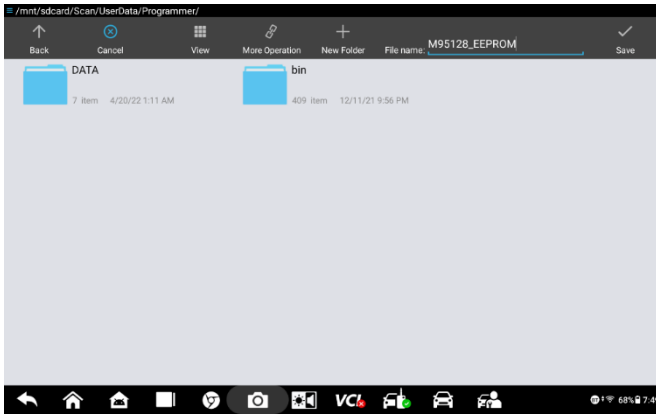

Figure 5-6 Save Data Screen

9. Select **Write** on the operations menu. The tablet will open the default folder, select the saved data and click **OK** to write it into a black chip. And a “Chip written successfully.” message displays.

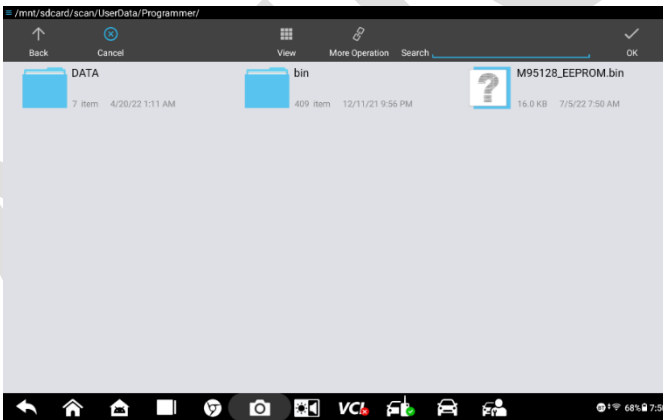

Figure 5-7 Write Screen

6. Diagnostics

The Diagnostics application can retrieve ECU information, read & erase DTCs, and view live data. The Diagnostics application can access the electronic control unit (ECU) for various vehicle control systems, including engine, transmission, antilock brake system (ABS), airbag system (SRS).

Diagnosis

The Diagnostics application enables a data link to the electronic control system of the test vehicle for vehicle diagnosis via OBDII connection. The application performs functional tests, retrieves vehicle diagnostic information such as trouble and event codes and live data for various vehicle control systems, such as engine, transmission, and ABS.

There are two main options available when accessing the Diagnosis section:

1. Auto Scan — starts auto scanning for all the available systems on the vehicle.
2. Control Unit — displays a selection menu of all available control units of the test vehicle.

After a section is made and the tablet establishes communication with the vehicle, the corresponding function menu or selection menu displays.

Auto Scan

The Auto Scan function performs a comprehensive scanning over all the ECUs in the vehicle to locate systems' faults and retrieve DTCs. The sample operation interface of Auto Scan displays as below:

Function Buttons

A brief description of the operations of the Auto Scan's Function Buttons' are displayed in the table below.

Table 6-1 Function Buttons in Auto Scan

Item	Description
Report	Displays the diagnostic data in the report form.
Quick Erase	Deletes codes. A warning message screen will display to inform you of possible data loss when this function is selected.
Fault Scan	Launches diagnostic scanning. It will change to Pause during scanning.
Pause	Suspends scanning and it will change to Continue button after tapping.
Enter System	Enters the ECU system.
ESC	Returns to the previous screen or exits Auto Scan.

Control Unit

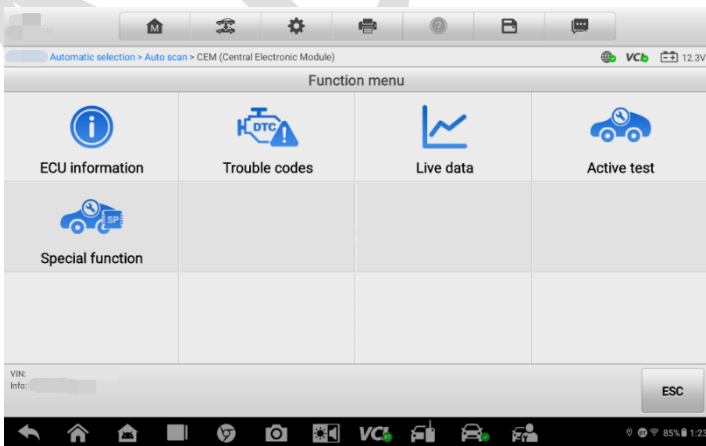

Figure 6-2 Function Menu Screen

Manually locate a required control system for testing through a series of selection choices. Follow the menu driven procedures and make proper selection; the application guides the user to the proper diagnostic function menu based on selections.

The Function Menu options vary slightly from different vehicles. The function menu may include:

ECU Information — provides the retrieved ECU information in detail. An information screen opens upon selection.

- **Trouble Codes** — includes Read Codes and Erase Codes functions, displaying detailed information of DTC records retrieved from the test vehicle's ECU and erasing DTC records and other data from the test vehicle's ECU.
- **Live Data** — retrieves and displays live data and parameters from the test vehicle's ECU.
- **Active Test** — provides specific subsystem and component tests. This selection may appear as *Actuators*, *Actuator Test*, or *Function Tests* and the tests options vary by vehicle manufacturer and model.
- **Special Function** — provides component adaptation or variant coding functions for custom configurations, and also allows you to reprogram adaptive values for certain components after making repairs. Depending on the test vehicle, this selection may sometimes appear as *Control Unit Adaptations*, *Variant Coding*, *Configuration* or something similar.

 **NOTE**

Toolbar functions such as saving and printing of test results can be performed throughout diagnostic testing. Data logging and access to help information are also available.

➤ **To perform a diagnostic function**

1. Establish communication with the test vehicle.
2. Identify the test vehicle by selecting from the menu options.
3. Select the **Diagnosis** section.
4. Locate the required system for testing by **Auto Scan** or through menu-driven selections in **Control Unit**.
5. Select the desired diagnostic function on the Function Menu.

ECU Information

This function retrieves and displays the specific information for the tested control unit, including unit type, version numbers and other specifications. The sample ECU Information screen displays as below:

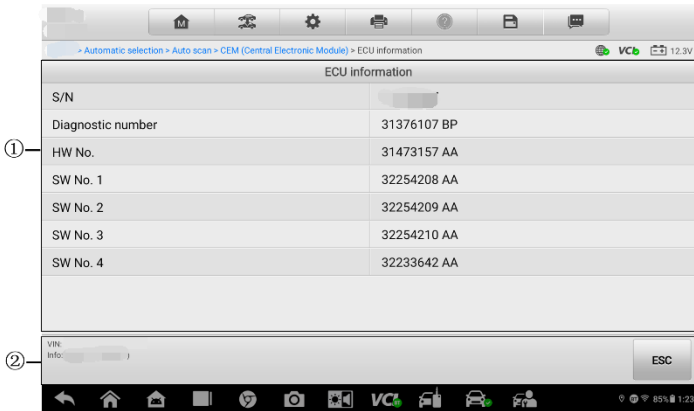

Figure 6-3 ECU Information Screen

1. Main Section — the left column displays the item names; the right column shows the specifications or descriptions.
2. Function Button — **ESC** (or **Back**) button is available; tap it to exit after viewing.

Trouble Codes

Read Codes

This function retrieves and displays the DTCs from the vehicle's control system. The Read Codes screen varies for each vehicle being tested. On some vehicles, freeze frame data can also be retrieved for viewing. The sample Read Codes screen displays as below:

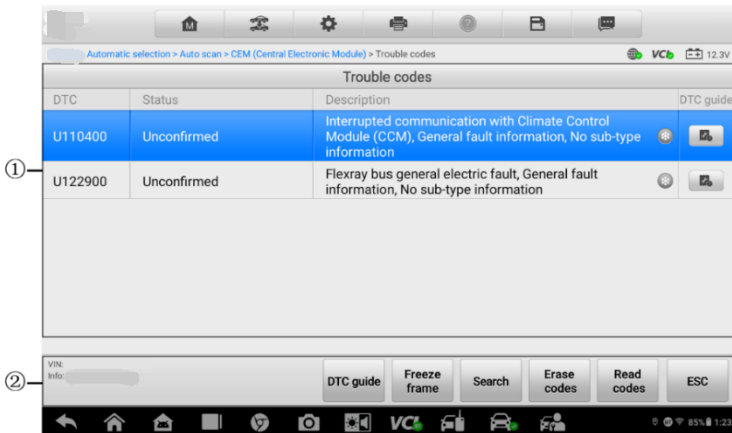

Figure 6-4 Trouble Codes Screen

1. Main Section

- DTC Column — displays the retrieved codes from the vehicle.
- Status Column — indicates the status of the retrieved codes.
- Description Column — detailed descriptions for the retrieved codes.
- Snowflake Icon — only displays when freeze frame data is available for viewing; selecting this icon will display a data screen, which looks and behaves similar to the Read Codes screen.
- DTC Guide — checks the related help information.

2. Function Button

- DTC Guide — checks the related help information.
- Freeze Frame — tap to view the freeze frame data.
- Search — tap to search related fault code information on Google.
- Erase Codes — tap to clear the diagnostic trouble code.
- Read Codes — retrieves and displays the DTCs from the vehicle control system. The Read Codes screen varies from each vehicle being tested.
- ESC — tap to return to the previous screen or exit the function.

Erase Codes

After reading the retrieved codes from the vehicle and certain repairs have been carried out, you can decide to erase the codes from the vehicle using this function. Before performing this function, make sure the vehicle's ignition key is in the ON (RUN) position with the engine off.

➤ **To erase codes**

1. Tap **Erase Codes** from the Function Menu.
2. A warning message displays to advice of data loss if this function is completed.
 - a) Tap **Yes** to continue. A confirming screen displays when the operation is successfully done.
 - b) Tap **No** to exit.
3. Tap **ESC** on the confirming screen to exit Erase Codes.
4. Perform the Read Codes function again to check if codes have been erased successfully.

Live Data

When this function is selected, the screen displays the data list for the selected module. The items available for any control module vary from one vehicle to another. The parameters display in the order that they are transmitted by the ECM, so expect variation between vehicles.

Gesture scrolling allows for quick movement through the data list. Use one or two fingers to swipe the screen up or down to locate the data you want. The figure below shows a typical Live Data screen:

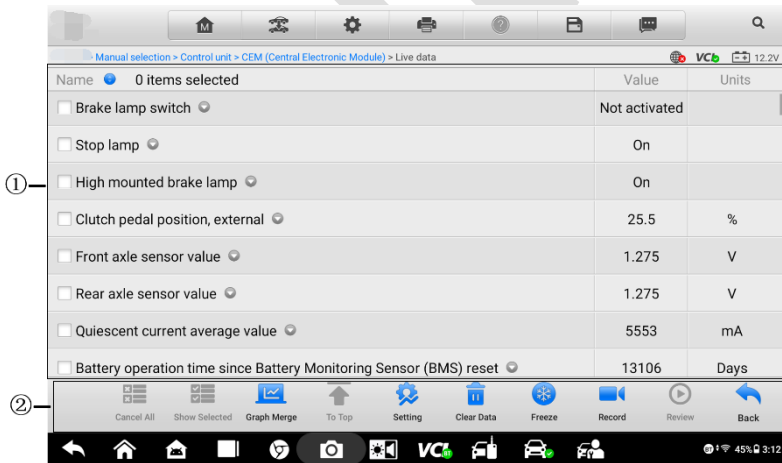

Figure 6-5 Live Data Screen

1. Main Section
 - Name Column — displays the parameter names.
 - a) Check Box — tap the check box on the left side of the parameter name to

make item selection. Tap the check box again to deselect the item.

- b) Drop-down Button — tap the drop-down button on the right side of the parameter name to open a sub menu, providing data display mode options.
- Value Column — displays the values of the parameter items.
- Unit Column — displays the unit for the parameters.
- To change the unit mode, tap the **Setting** button on the top toolbar and select a required mode. See [Unit](#) for more information.

Display Mode

There are four types of display modes available for data viewing. Select the proper mode for the diagnostic purpose.

Tap the drop-down button on the right side of a parameter to open a submenu. A total of 7 buttons will be displayed: The 4 buttons to the left represent different data display modes, plus one Information button, active when additional information is available, and one Unit Change button, for switching the unit of displayed data, and one Trigger button, tap to open the "Trigger Settings" screen.

Each parameter item displays the selected mode independently.

- 1) Analog Gauge Mode — displays the parameters in form of an analog meter graph.
- 2) Text Mode — this is the default mode which displays the parameters in texts and shows in list format.

NOTE

Status parameters, such as a switch reading, can primarily be viewed in text form such as ON, OFF, ACTIVE, and ABORT. Whereas, value parameters, such as a sensor reading, can be displayed in text mode and additional graph modes.

- 3) Waveform Graph Mode — displays the parameters in waveform graphs.

When this mode is selected, five control buttons display on the right side of the parameter item for manipulation of display status.

- **Settings** Button (**SetY**) — sets the minimum and maximum value of the Y axis.
- **Scale** Button — changes the scale values that are displayed below the waveform graph. There are four scales available: x1, x2, x4 and x8.
- **Edit** Button — edit the waveform color and the line thickness.
- **Zoom-in** Button — tap once to display the selected data graph in full screen.
- **Exit** Button — tap to exit the waveform graph mode.

Full Screen Display — this option is only available in the waveform graph mode, and primarily used in Graph Merge status for data comparison. Under this mode, there are four control buttons available on the top-right side of the screen.

- **Scale** Button — tap to change the scale values, which are displayed below the

waveform graph. There are four scales available: x1, x2, x4 and x8.

- **Edit** Button — tap to open an edit window, in which you can set the waveform color and the line thickness displayed for the selected parameter item.
- **Zoom-out** Button — tap to exit full screen display.
- **Exit** Button — tap to exit the waveform graph mode.

➤ **To edit the waveform color and line thickness in a data graph**

1. Select 1 to 3 parameter items to display in Waveform Graph mode.
 2. Tap the **Zoom-in** button on the right to display the data graph in full screen.
 3. Tap the **Edit** button, an edit window appears.
 4. Select a parameter item on the left column.
 5. Select a desired sample color from the middle column.
 6. Select a desired sample line thickness from the right column.
 7. Repeat step 3-5 to edit the waveform for each parameter item.
 8. Tap **Done** to save the setting and exit, or tap **Cancel** to exit without saving.
- 4) Digital Gauge Mode — displays the parameters in form of a digital gauge graph.

Trigger Settings

On the trigger settings screen, you can set a standard range by filling in a Minimum value and a Maximum value. When exceeding this range, the trigger function will be executed and the device will automatically record and save the generated data. You can check the saved live data by tapping the **Review** button at the bottom of the screen.

Tap the drop-down button on the right side of the parameter name to open a submenu. The Trigger button is the last one in the submenu. Tap to display the trigger settings window.

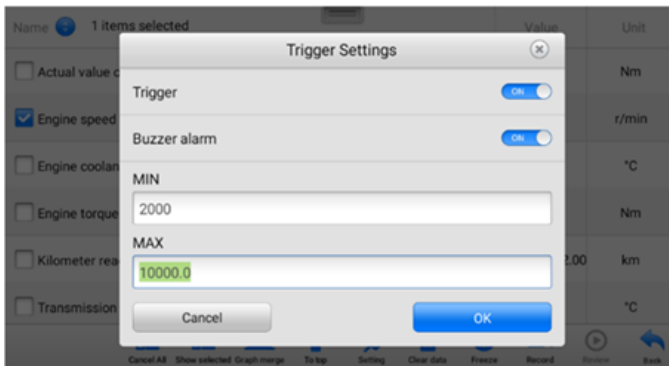

Figure 6-6 Trigger Setting Screen

Two buttons and two input boxes are available in the Trigger Settings window.

- a) **Trigger** — switches the trigger on and off. The trigger is **On** by default.
- b) **Buzzer Alarm** — switches the alarm on and off. The alarm function makes a beep sound as an alert when the data reading reaches the preset minimum or maximum point. The buzzer alarm will only sound at the first trigger.
- c) **MIN** — tap this input box to display a virtual keyboard to enter the required lower limit value.
- d) **MAX** — tap this input box to display a virtual keyboard to enter the required upper limit value.

When the trigger is successfully set, a trigger mark displays in front of the parameter name. The mark disappears when it is not triggered, and displays when triggered. Moreover, two horizontal lines display on each of the data graphs (when Waveform Graph Mode is applied) to indicate the alarm point. The limit lines are shown in different colors to differentiate them from the parameter waveforms.

2. Function Buttons

The operations of available function buttons on Live Data screen are described below:

Cancel All — tap this button to cancel all selected parameter items. Up to 50 parameters can be selected at one time.

Show Selected/Show All — tap this button to switch between the top options; one displays the selected parameter items, the other displays all the available items.

Graph Merge — taps this button to merge selected data graphs (for Waveform Graph Mode only). This function is useful for comparisons between different parameters.

 **NOTE**

In this mode, Graph Merge can only display up to three parameter items.

➤ **To merge selected data graphs**

- 1) Select parameter items to be merged.
- 2) Tap the **Graph Merge** button at the bottom of the Live Data Screen.
 - a) This mode only supports parameters that can be represented digitally. If non-digital parameters are selected, a message will display advising the user that the selected parameters are not supported in this mode and to select 2 to 5 digital parameters. Tap the **Got It** button to return to the previous screen and select supported parameters.
 - b) If parameters are selected that are not supported in this mode, a message will display advising the user to select parameters that are supported. A message will also display if more than 5 parameters have been selected. Please select 2 to 5 of the supported parameters and tap the **OK** button to merge.
- 3) Tap the **Cancel Merging** button at the bottom of the Live Data screen to cancel merge.

To Top — moves a selected data item to the top of the list.

Setting — tap button to set recording duration. Eleven options are available: 5 seconds, 15 seconds, 30 seconds, 60 seconds, 90 seconds, 3 minutes, 5 minutes, 10 minutes, 20 minutes, 30 minutes, and 60 minutes.

➤ **To set live data record duration**

1. Tap **Setting** button at the bottom of the Live Data screen.
2. Tap the > button to the right of **Recording time after trigger** bar and select a time length.

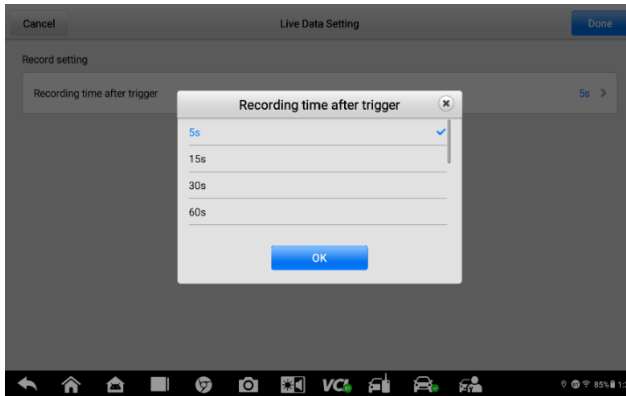

Figure 6-7 Setting Mode in Live Data Screen

3. Tap **OK** to save the setting and return to the Live Data Setting screen, or tap the **X** button at the upper-right corner to exit without saving.
4. Tap **Done** at the upper-right corner of the Live Data Setting screen to confirm and save the setting, and return to the Live Data screen, or tap **Cancel** to exit without saving.

Clear Data — clears all previously retrieved parameter values at a particular cutting point.

Freeze — displays the retrieved data in freeze mode.

- Previous Frame — displays previous frame if the freeze frame data.
- Next Frame — advances to the next frame in the freeze frame data.
- Play/Pause — tap to play/pause the frozen data.
- Resume — tap to exit the freeze data mode and return normal data display.

Record — starts recording the live data of the selected data. Tap the **Record** button at the bottom of the Live Data screen. A message will display prompting user to select parameters to record. Tap the **Got It** button to confirm. Scroll down and select data to record. Tap the **Record** button to start recording. Tap the **Resume** button to stop recording. The recorded live data can be viewed in the Review section at the bottom of the Live Data screen. The recorded data can also be reviewed in the Data Manager application.

Review — reviews the recorded data. Tap the Review button to display a recording list and select one item to review.

NOTE

Only the data recorded during the current operation can be reviewed on the Live Data screen. All the historical recorded data can be reviewed in "Review Data" in the Data Manager application.

- Previous Frame — switches to the previous frame of recorded data.
- Next Frame — switches to the next frame of recorded data.
- Play/Pause — tap to play/pause the recorded data.
- Show Selected — displays the selected parameter items.
- Graph Merge — merges selected data graphs.
- Back — exits the review, and return to the Live Data screen.

Back — returns previous screen or exits the function.

Active Test

The Active Test function is used to access vehicle-specific subsystem and component tests. Available test varies by vehicle manufacturer, year, and model, and only the available tests display in the menu.

During an active test, the tablet sends commands to the ECU in order to drive the actuators. This test determines the integrity of the system or parts by reading the engine ECU data, or by monitoring the operation of the actuators, such as switching a solenoid, relay, or switch, between two operating states.

Selecting **Active Test** opens a menu of test options that varies by vehicle make and model. Selecting a menu option activates the test. Follow all screen instructions while performing tests. How and what information is presented on the screen varies according to the type of test being performed. Some toggle and variable control tests display Active Test Controls at the top of the screen with data stream information below, or vice versa.

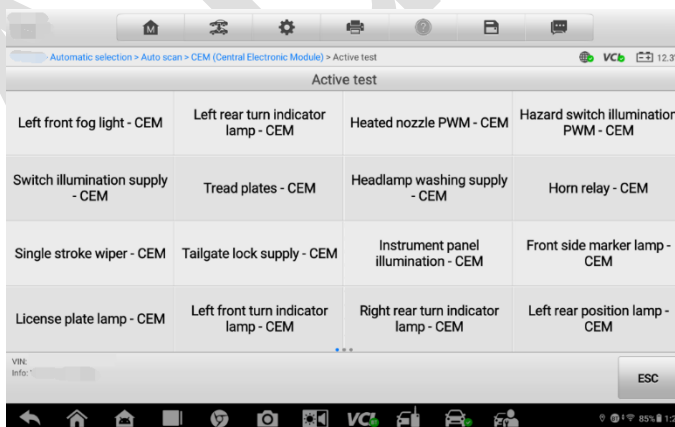

Figure 6-8 Active Test Screen

The function buttons at the lower-right corner of the Active Test screen manipulate the test signals. The operational instructions are displayed on the main section of the test screen. Simply follow the on-screen instructions and make appropriate selections to complete the tests. Each time when an operation is successfully executed, message such as “Command Finished”, “Activation Successful”, or something similar displays.

Tap the **ESC** function button to exit the test when finished.

Special Function

These functions perform various component adaptations, allowing you to recalibrate or configure certain components after making repairs or replacement.

The main section of the Adaptation Operation screen displays a list of operational and vehicle status information, which mainly consists of four parts:

1. The first part in the top line shows the description of the operation being performed, and the execution status is displayed on the right, such as Completed, or Activated.
2. The second part shows the preconditions or requirements for executing the operation being selected.
3. The third part displays the current conditions of the vehicle control module being learned for comparison to the preconditions suggested by the second part. If the current condition of the control module is out of the suggested limit value, you must adjust the vehicle condition to meet the requirement.
4. The last part displays the instruction of how to use the function button at the lower-right corner of the screen to manipulate the teach-in operations.

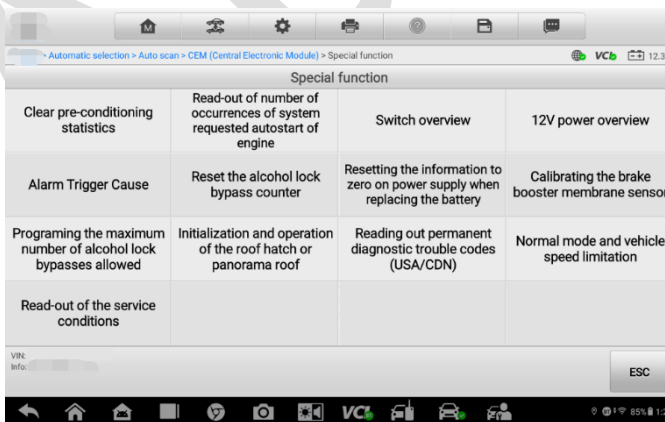

Figure 6-9 Special Function Screen

Read the information carefully and check the vehicle condition accordingly, when you are sure that the vehicle is ready to perform the adaptation, simply follow the instructions provided to make appropriate selections. When the operation is done, an execution status message such as Completed, Finished or Successful, displays.

Tap the **ESC** button to exit the function.

Generic OBDII Operations

A fast-access option for OBDII/EOBD vehicle diagnosis is available on the Vehicle Menu screen. This option presents a quick way to check for DTCs, isolate the cause of an illuminated malfunction indicator lamp (MIL), check monitor status prior to emissions certification testing, verify repairs, and perform a number of other services that are emissions-related. The OBD direct access option is also used for testing OBDII/EOBD compliant vehicles that are not included in the Diagnostics database.

Functions of the diagnostics toolbar buttons at the top of the screen are the same as those available for specific vehicle diagnostics. See [Table 4-2 Operation Toolbar Buttons](#) for details.

General Procedure

➤ **To access the OBDII/EOBD diagnostics functions**

1. Tap the **Diagnostics** application button from the MaxiIM Job Menu. The Vehicle Menu displays.
2. Tap the **EOBD** button. There are two options to establish communication with the vehicle.
 - ✧ **Auto Scan** — when this option is selected the diagnostic tool attempts to establish communication using each protocol in order to determine which one the vehicle is broadcasting on.
 - ✧ **Protocol** — when this option is selected the screen opens a submenu of various protocols. A communication protocol is a standardized way of data communication between an ECM and a diagnostic tool. Global OBD may use several different communication protocols.
3. Select a specific protocol under the **Protocol** option. Wait for the OBDII Diagnostic Menu to appear.



NOTE

Tapping the  button displayed beside the function name opens a bubble with additional function information.

4. Select a function option to continue.

- **DTC & FFD**
- **I/M Readiness**
- **Live Data**
- **On-Board Monitor**
- **Component Test**
- **Vehicle Information**
- **Vehicle Status**

NOTE

Some functions are supported only on certain vehicle makes.

Function Descriptions

This section describes the various functions of each diagnostic option:

DTC & FFD

When this function is selected, the screen displays a list of Stored Codes and Pending Codes. When the Freeze Frame data of certain DTCs are available for viewing, a snowflake button will display on the right side of the DTC item.

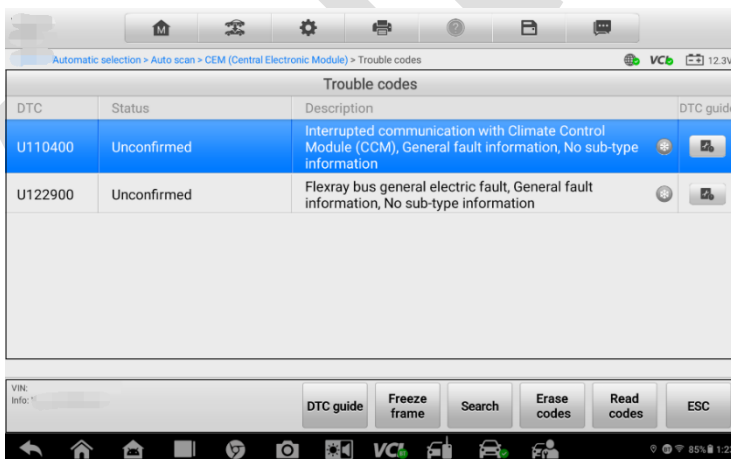

Figure 6-10 DTC & FFD Screen

The erase codes function can be applied by tapping the **Erase Codes** button at the bottom of the screen.

- **Stored Codes**

Stored codes are the current emission related DTCs from the ECM of the vehicle. OBDII/EOBD Codes have a priority according to their emission severity, with higher priority codes overwriting lower priority codes. The priority of the code determines the illumination of the MIL and the codes erase procedure. Manufacturers rank codes differently, so expect to see differences between makes.

- **Pending Codes**

These are codes whose setting conditions were met during the last drive cycle, but need to be met on two or more consecutive drive cycles before the DTC actually sets. The intended use of this service is to assist the service technician after a vehicle repair and after clearing diagnostic information, by reporting test results after a driving cycle.

- a) If a test failed during the driving cycle, the DTC associated with that test is reported. If the pending fault does not occur again within 40 to 80 warm-up cycles, the fault is automatically cleared from memory.
- b) Test results reported by this service do not necessarily indicate a faulty component or system. If test results indicate another failure after additional driving, then a DTC is set to indicate a faulty component or system, and the MIL is illuminated.

- **Freeze Frame**

In most cases the stored frame is the last DTC that occurred. Certain DTCs, which have a greater impact on vehicle emission, have a higher priority. In these cases, the top prioritized DTC is the one for which the freeze frame records are retained. Freeze frame data includes a “snapshot” of critical parameter values at the time the DTC is set.

- **Erase Codes**

This option is used to clear all emission related diagnostic data such as, DTCs, freeze frame data and manufacturer specific enhanced data from the vehicle’s ECM.

A confirmation screen displays when the clear codes option is selected to prevent accidental loss of data. Select **Yes** on the confirmation screen to continue or **No** to exit.

I/M Readiness

This function is used to check the readiness of the monitoring system. It is an excellent function to use prior to having a vehicle inspected for compliance to a state emissions program. Selecting **I/M Readiness** opens a submenu with two choices:

- **Since DTCs Cleared** — displays the status of monitors since the last time the DTCs are erased.
- **This Driving Cycle** — displays the status of monitors since the beginning of the current drive cycle.

Live Data

This function displays the real time PID data from ECU. Displayed data includes analog inputs and outputs, digital inputs and outputs, and system status information broadcast on the vehicle data stream.

Live data can be displayed in various modes, see [Live Data](#) for detailed information.

On-Board Monitor

This option allows you to view the results of On-Board Monitor tests. The tests are useful after servicing or after erasing a vehicle's control module memory.

Component Test

This service enables bi-directional control of the ECM so that the diagnostic tool is able to transmit control commands to operate the vehicle systems. This function is useful in determining whether the ECM responds to a command well.

Vehicle Information

The option displays the vehicle identification number (VIN), the calibration identification, and the calibration verification number (CVN), and other information of the test vehicle.

Vehicle Status

This item is used to check the current condition of the vehicle, including communication protocols of OBDII modules, retrieved codes amount, status of the Malfunction Indicator Light (MIL), and other additional information.

Exiting Diagnostics

The Diagnostics application remains open as long as there is an active communication with the vehicle. You must exit the diagnostics operation to stop all communications with the vehicle before closing the Diagnostics application.

NOTE

Damage to the vehicle electronic control module (ECM) may occur if communication is disrupted. Make sure all connections, such as USB cable and wireless connection, are properly connected at all times during testing. Exit all tests before disconnecting the test connection or powering down the tool.

➤ **To exit the Diagnostics application**

1. On an active diagnostic screen, tap the **Back** or **ESC** function button to exit a diagnostic session step-by-step.
2. Or tap the **Vehicle Swap** button on the diagnostics toolbar to return to the Vehicle Menu screen.
3. From the Vehicle Menu screen, tap the **Home** button on the top toolbar; or tap the **Back** button on the navigation bar at the bottom of the screen.
4. Or tap the **Home** button on the diagnostics toolbar to exit the application directly and go back to the MaxiIM Job Menu.

Now, the Diagnostics application is no longer communicating with the vehicle and it is safe to open other MaxiIM applications, or exit the MaxiIM Diagnostic System and return to the Android System's Home screen.

Autel

7. Service

The Service section is specially designed to provide you with quick access to the vehicle systems for various scheduled service and maintenance performances. The typical service operation screen is a series of menu driven executive commands. By following the on-screen instructions to select appropriate execution options, enter correct values or data, and perform necessary actions, the system will guide you through the complete performance for various service operations.

The most commonly performed service functions include:

- Oil Reset Service
- EPB Service
- BMS Service
- SAS Service
- TPMS Service

After entering each special function, the displayed screen consists of two applications: **Diagnosis** and **Hot Functions**. The **Diagnosis** is for you to read/clear data since this is necessary after some special functions. **Hot Functions** consists of sub functions of the selected special function.

Oil Reset

This function allows you to perform reset for the Engine Oil Life system, which calculates an optimal oil life change interval depending on the vehicle driving conditions and climate. The Oil Life Reminder must be reset every time the oil is changed, so the system can calculate when the next oil change is required.

! IMPORTANT

Always reset the engine oil life to 100% after every oil change.

🔧 NOTE

1. All required work must be carried out before the service indicators are reset. Failure to do so may result in incorrect service values and cause DTCs to be stored by the relevant control module.
2. For some vehicles, the scan tool can perform added functionality to reset additional service lights (maintenance cycle, service interval). Taking BMW as an example, its service reset function includes engine oil, spark plugs, front/rear brakes, coolant, particle filter, brake fluid, micro filter, vehicle inspection, exhaust emission inspection

and vehicle check.

Electronic Parking Brake (EPB)

This function has a multitude of usages to maintain the electronic braking system safely and effectively. The applications include deactivating and activating the brake control system, assisting with brake fluid control, opening and closing brake pads, and setting brakes after disc or pad replacement, etc.

EPB Safety

It may be dangerous to perform Electronic Parking Brake (EPB) system maintenance, so before you begin the service work, please keep these rules in mind.

- ✓ Ensure that you are fully familiar with the braking system and its operation before commencing any work.
- ✓ The EPB control system may be required to be deactivated before carrying out any maintenance/diagnostic work on the brake system. This can be done from the tool menu.
- ✓ Only carry out maintenance work when the vehicle is stationary and on level ground.
- ✓ Ensure that the EPB control system is reactivated after the maintenance work has been completed.

NOTE

Autel accepts no responsibility for any accident or injury arising from the maintenance of the Electronic Parking Brake system.

Battery Management System (BMS)

The BMS (Battery Management System) allows the scan tool to evaluate the battery charge state, monitor the close-circuit current, register the battery replacement, and activate the rest state of the vehicle.

NOTE

1. This function is not supported by all vehicles. The screens shown in this section are examples.
 2. The sub functions and actual test screens of the BMS may vary for different test vehicles, please follow the on-screen instructions to make correct option selection.
-

The vehicle may use either a sealed lead-acid battery or an AGM (Absorbed Glass Mat) battery. Lead acid battery contains liquid sulphuric acid and can spill when overturned.

AGM battery (known as VRLA battery, valve regulated lead acid) also contains sulphuric acid, but the acid is contained in glass mats between terminal plates.

It is recommended that the replacement aftermarket battery has the same specifications, such as capacity and type, with the battery used in the vehicle. If the original battery is replaced with a different type of battery (e.g. a lead-acid battery is replaced with an AGM battery) or a battery with a different capacity (mAh), the vehicle may require reprogramming the new battery type in addition to performing the battery reset. Consult the vehicle manual for additional vehicle-specific information.

Steering Angle Sensor (SAS) Service

Steering Angle Sensor Calibration permanently stores the current steering wheel position as the straight-ahead position in the steering angle sensor EEPROM. Therefore, the front wheels and the steering wheel must be set exactly to the straight-ahead position before calibration. In addition, the vehicle identification number is also read from the instrument cluster and stored permanently in the steering angle sensor EEPROM. On successful completion of calibration, the steering angle sensor fault memory is automatically cleared.

Calibration must always be carried out after the following operations:

- Steering wheel replacement
- Steering angle sensor replacement
- Any maintenance that involves opening the connector hub from the steering angle sensor to the column
- Any maintenance or repair work on the steering linkage, steering gear or other related mechanism
- Wheel alignment or wheel track adjustment
- Accident repairs where damage to the steering angle sensor or assembly, or any part of the steering system may have occurred

NOTE

1. Autel accepts no responsibility for any accident or injury arising from servicing the SAS system. When interpreting DTCs retrieved from the vehicle, always follow the manufacturer's recommendation for repair.
 2. All software screens shown in this manual are examples, actual test screens may vary for each vehicle being tested. Observe the menu titles and on-screen instructions to make correct option selections.
 3. Before starting the procedure, make sure the vehicle has ESC. Look for the button on dash.
-

Tire Pressure Monitoring System (TPMS)

This function allows you quickly look up the tire sensor IDs from the vehicle's ECU, as well as to perform TPMS replacement and reset procedures after tire sensors are replaced.

Autel

8. Update

The Update application allows you to download the latest released software. The updates can improve the MaxiIM applications' capabilities, typically by adding new tests, new models, or enhanced applications to the database.

The tablet automatically searches for available updates for all of the MaxiIM software when it is connected to the internet. Any updates that are found can be downloaded and installed on the device. This section describes installing an update to the MaxiIM System.



Figure 8-1 Update Screen

1. Navigation and Controls

- Home Button — returns the MaxiIM Job Menu.
- IMMO Tab — displays all available IMMO software for vehicles.
- Diagnostics Tab — displays all available vehicle diagnostic software.
- Renew Button — Tap on **Renew** Button to extend subscription.
- Refresh Button — refreshes the available update list.
- Search Bar — search specific update item by inputting the file name, for example: a vehicle make.
- My Devices — accesses the devices linked with the user account.
- My Orders — accesses the orders that the user account has placed.

- My Coupons — accesses the coupons that the user account have.

2. Function Buttons

- Name (A – Z) — changes the display sequence of available updates. There are five options: Date (Old to New), Date (New to Old), Frequency, Name (A – Z), and Name (Z – A).
- Bulk Update — allows you to select one or more or all items to update at once.

3. Main Section

- Left Column — displays vehicle brands.
- Middle Column — displays a brief introduction about the new changes to the software operation or capabilities. Tap  button to open an information screen to view more details, and tap the dim area around to close the window.
- Right Column — according to the operation status of each software item, the button displays differently.
 - a) **Get** — tap it to update the selected item.
 - b) **Pause** — means the updating procedure stops. Tap it to resume the updating procedure.
 - c) **Downloading** — means the selected item is updating. Tap it to stop the updating procedure.

➤ To update the software

1. Make sure the Tablet is connected to a power source with stable access to the internet.
2. Tap the **Update** application button on the MaxiIM Job Menu; or tap the update notification message when received one; or tap the **Update** icon on Vehicle Menu in Diagnostics application. The Update application screen displays.
3. Check all available updates:
 - If you decide to update all the items of IMMO/Diagnostics softwares, select **IMMO/Diagnostics** Tab and then tap the **Bulk Update — Select All** button;
 - If you only want to update one or some of the item(s), tap the **Get** button on the right column of the specific item(s) or tap **Bulk Update**, then select the item(s) you want to update.
4. Tap the **Downloading** to suspend the updating process. When you tap **Pause** to renew the update, the updating process will resume from the break point.
5. When the updating process is completed, the software will be installed automatically. The previous version will be replaced.

9. Settings

Selecting Settings application opens a setup screen, on which you can adjust default setting and view information about the MaxiIM system. There are nine options available for the MaxiIM system settings:

- **Units**
- **Language**
- **Printing Settings**
- **Push Notifications**
- **Scan Report**
- **Auto Update**
- **Vehicle List**
- **System Settings**
- **About**

This section describes the operation procedures for the settings.

Unit

This option allows you to adjust the measurement unit for the diagnostic system.

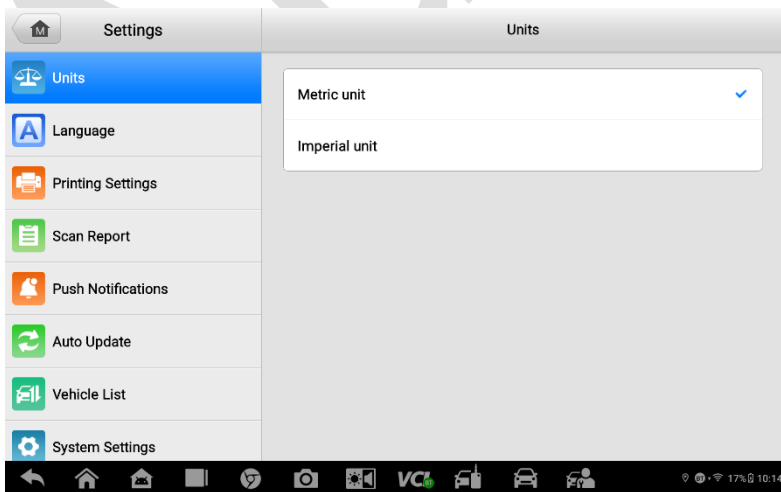

Figure 9-1 Units Screen

➤ **To adjust the units setting**

1. Tap the **Settings** application on the MaxiIM Job Menu.
2. Tap the **Units** option on the left column.
3. Select the required measurement unit, Metric or Imperial. A tick icon will display to the right of the selected unit.
4. Tap the **Home** button on the top left corner to return to the MaxiIM Job Menu. Or select another setting option for system setup.

Language

This option allows you to adjust the display language for the MaxiIM system.

➤ **To adjust the language setting**

1. Tap the **Settings** application on the MaxiIM Job Menu.
2. Tap the **Language** option on the left column.



Figure 9-2 Language Screen

3. Select the required language. A tick icon will display to the right of the selected language.
4. Tap the **Home** button on the top left corner to return to the MaxiIM Job Menu. Or select another setting option for system setup.

Printing Settings

This option allows you to print any data or information anywhere and anytime via Wi-Fi connection.

➤ **To setup the printer connection**

1. Tap the **Settings** application on the MaxiIM Job Menu.
2. Tap the **Printing Settings** option on the left column.
3. Tap the **Print via PC-Link** or **Print via Wi-Fi** to conform the print method. A check mark will display to the right of the selected item.
4. Tap the **Home** button on the top left corner to return to the MaxiIM Job Menu. Or select another setting option for system setup.

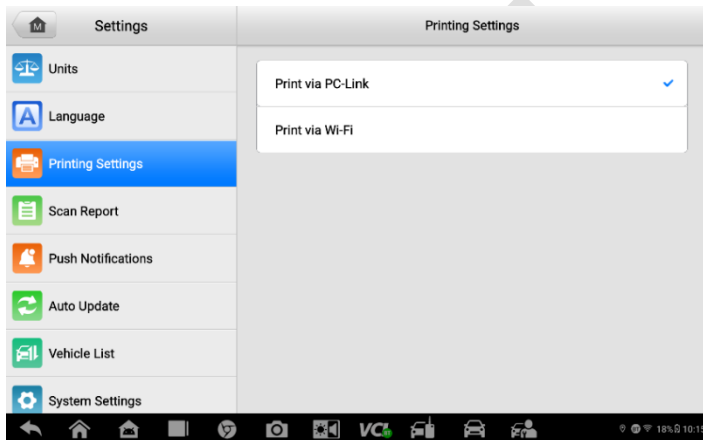

Figure 9-3 Printing Settings Screen

NOTE

The **MaxiSys Printer** runs automatically after the installation. Before printing, make sure the Tablet is connected to the same network with the computer, either via Wi-Fi or LAN. And the computer is connected to a printer.

➤ **To install the MaxiSys Printer driver program**

1. Download Maxi PC Suite on www.autel.com > Support > Downloads > Autel Update Tools. Select **Maxi PC Suite** and click **Download here** to install the printer to your PC.
2. Double click the setup.exe file.
3. Select the installation language and the wizard will load momentarily.
4. Follow the instructions on the screen and click **Next** to continue.
5. Click **Install**. The printer driver program will be installed to the PC.
6. Click **Finish** to complete the installation.

➤ **To print a file via PC**

1. Run the PC Link on the computer.
2. Click **Test Print** to make sure the printer is working successfully.
3. Tap the **Print** button on the toolbar of the tablet. A test document will be created and sent to the computer.
 - 1) If the Auto Print option in the MaxiSys Printer is selected, the MaxiSys Printer will print the received document automatically.
 - 2) If the Auto Print option is not selected, click **Open PDF File** button to view files. Select the file(s) you want to print and click **Print**.

Scan Report

This option automatically synchronizes the diagnostics information of the vehicle to the vehicle history and forms a diagnostics report for the user to upload. Tap the **ON/OFF** button to enable/disable the Scan Report or Report Upload to Cloud function. The button appears blue if the function is enabled and is gray if the function is disabled.

 **NOTE**

This function is only available in some areas such as North America.

Push Notifications

This option allows you to manage notifications. The Notification Preference is turned on by default and cannot be turned off by users so that certain system notifications such as system security warnings won't be blocked. Internet access is required for receiving on-line messages.

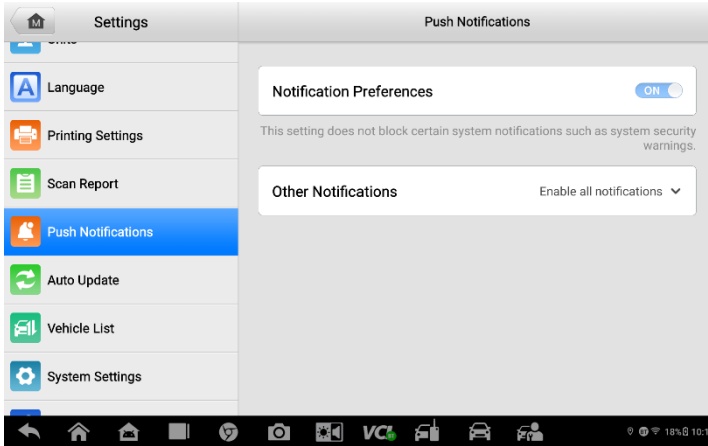

Figure 9-4 Push Notifications Screen

➤ To manage other notifications

1. Tap the **Settings** application on the MaxiIM Job Menu.
2. Tap the **Push Notifications** option on the left column.
3. Tap the **▼** button on the right to open a drop-down list.
4. There are four options: **Enable all notifications**, **Limit to 3 notifications or less per week**, **Limit to 1 notification per week**, and **Disable all notifications**. Select whichever you want.
5. Tap the **Home** button on the top-left corner to return to the MaxiIM Job Menu. Or select another setting option for the system setup.

Notification message will display on the MaxiIM Job Menu. Press on the message bar and drag it down, and the received messages are shown in the list, slide the list up or down to view all if the message list covers more than one screen.

Tapping a specific message launches the corresponding application. For example, if you tap on an Update notification message, the Update application will be launched.

Auto Update

The Auto Update allows the tool to automatically update the OS, the MaxiIM system, and the vehicle software. All you need to do is switch ON by tapping the button on the right side of each and set the desired automatic update time.

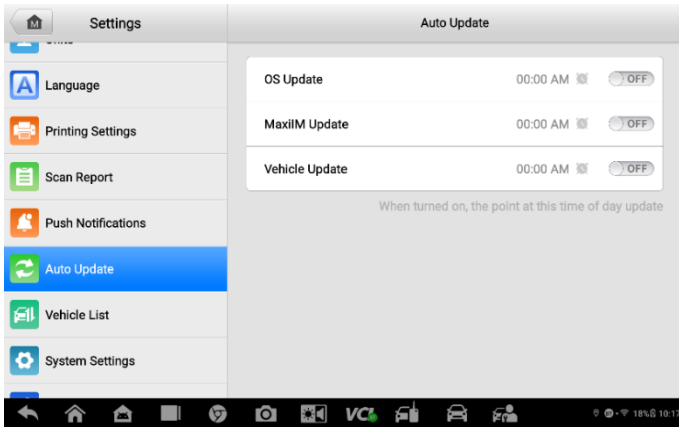

Figure 9-5 Auto Update Screen

➤ **To set auto system or vehicle update**

1. Tap the **Settings** application on the MaxiIM Job Menu.
2. Tap the **Auto Update** option on the left column. The three auto update items list on the right.
3. Switch the **ON** button on the right of item that you want to auto update.
4. Tap on the time to set the time of the day for updating. If the update time is set, the selected software will be automatically updated at the configured time.

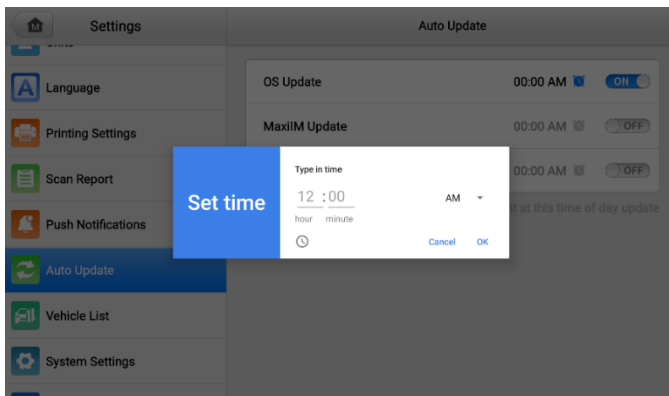



Figure 9-6 Set Time Screen

5. Tap the **Home** button on the top-left corner to return to the MaxilM Job Menu. Or select another setting option for the system setup.

 **NOTE**

Internet connection is necessary for auto update, otherwise it would not work even if you have already switch it on. Make sure the tool is connected to the Internet for the time you have set.

Vehicle List

This option allows you to sort the vehicles either by alphabetical order or by frequency of use.

➤ **To adjust the vehicle list setting**

1. Tap **Settings** on the MaxilM Job Menu.
2. Tap **Vehicle List** on the left column.
3. Select the desired sort type. A check mark will display to the right of the selected item.
4. Tap the **Home** icon on the top left corner to return the MaxilM Job Menu, or select another settings option for the system setup.

System Settings

This option provides you a direct access to the Android background system setting screen, on which you can adjust various system settings for the Android system platform,

regarding wireless and networks settings, various device settings such as sound and display, as well as system security settings, and check the associated information about the Android system, etc.

You may refer to Android documentation for additional information about Android system settings.

About

The About option provides information of the MaxiIM diagnostic device regarding the product name, version, hardware, and serial number, etc.

➤ **To check the MaxiIM product information in About**

1. Tap the **Settings** application on the MaxiIM Job Menu.
2. Tap the **About** option on the left column. The product information screen displays on the right.
3. Tap the **Home** button on the top left corner to return to the MaxiIM Job Menu, or select another setting option for the system setup after viewing.

10. Remote Desktop

The Remote Desktop application launches the TeamViewer Quick Support program, which is a simple, fast and secure remote control screen. You can use the application to receive ad-hoc remote support from Autel's support center, colleagues, or friends, by allowing them to control your MaxiM tablet on their PC via the TeamViewer software.

If you think of a TeamViewer connection as a phone call, the TeamViewer ID would be the phone number under which all TeamViewer Clients can be reached separately. Computers and mobile devices that run TeamViewer are identified by a globally unique ID. The first time the Remote Desktop application is started, this ID is generated automatically based on the hardware characteristics and will not change later on.

Make sure the tablet is connected to the Internet before launching the Remote Desktop application, so that the tablet is accessible to receive remote support from the third party.

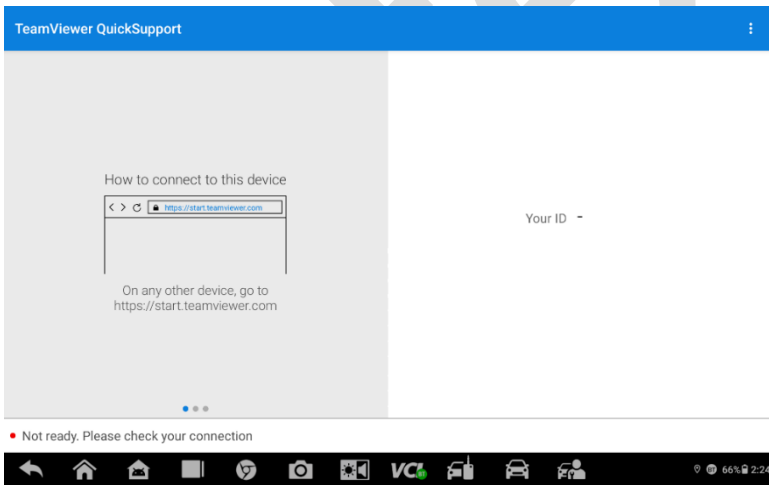

Figure 10-1 Remote Desktop Screen

- **To receive remote support from a partner**
 1. Tap the **Remote Desktop** application on the MaxiM Job Menu. The TeamViewer screen displays and the device ID is generated and shown.
 2. Your partner must install the Remote Control software to his/her computer by downloading the TeamViewer full version program online (<http://www.teamviewer.com>), and then start the software on his/her computer at the same time, in order to provide support and take control of the Tablet remotely.

3. Provide your ID to the partner, and wait for him/her to send you a remote control request.
4. A popup displays to ask for your confirmation to allow remote control on your device.
5. Tap **Allow** to accept, or tap **Deny** to reject.

Refer to the associated TeamViewer documents for additional information.

Autel

11. Data Manager

The Data Manager application is used to store, print, and review the saved files, manage the workshop information, customer information records, and keep vehicle history records.

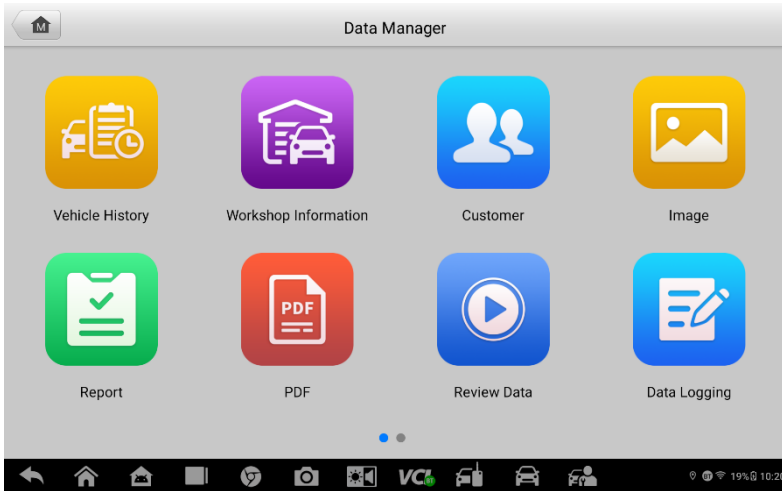











Figure 11-1 Data Manager Main Screen

Tapping the Data Manager application opens the file system menu. There are nine main functions available.

The table below briefly describes each of the function buttons in the Data Manager application.

Button	Name	Description
	Vehicle History	Reviews the diagnostic history record.
	Workshop Information	Edits the information of workshops.
	Customer	Creates a new customer account file.
	Image	Reviews the screenshots.

Button	Name	Description
	Report	Views the local reports on your tablet or scan a QR code to view and share the reports via your smartphone browser.
	PDF	Reviews the diagnostic reports.
	Review Data	Reviews the recorded data.
	Data Logging	Reviews the communication data and ECU information of the vehicle. The saved data can be reported and sent to the technical center via the internet.
	Apps Uninstall	Uninstalls applications.

Vehicle History

This function stores records of vehicle history, including vehicle information and the retrieved DTCs from previous diagnostics sessions. Test information is summarized and displayed in an easy-to-read table listing. The Vehicle History also provides direct access to the previously tested vehicles and allows you to directly restart a diagnostics session without needing to perform auto or manual vehicle selection.

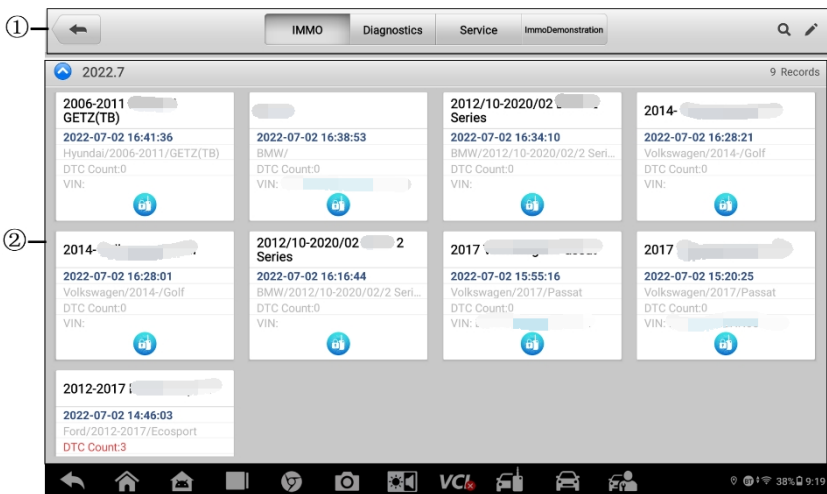

Figure 11-2 Vehicle History Screen

- ① Top Toolbar Buttons — displays navigation and application controls
- ② Main Section — displays all the vehicle history records.

➤ **To activate a test session for the recorded vehicle**

1. Tap **Data Manager** on the MaxiIM Job Menu.
2. Tap **Vehicle History** to open the screen. Tap the **IMMO**, **Diagnostics**, or **Service** tab to select test records.
3. Tap **IMMO** icon at the bottom of the thumbnail of a vehicle record.
4. The **IMMO** screen of the vehicle displays and a new IMMO session is activated, see [IMMO](#) for detailed instructions on vehicle IMMO operations. Or,
5. Select a vehicle thumbnail. A historical test record screen displays. Review the recorded information of the vehicle, and tap the **IMMO** button on the upper-right corner to continue IMMO.

Historical Test Record

The historical test record is a detailed data form of the tested vehicle, which includes general vehicle information, service record, customer information, and the diagnostic trouble codes retrieved from the previous test sessions. Technician notes will also display if present.

 **NOTE**

The MaxiIM tablet must connect to the VCI to restart test sessions on the previously tested vehicles.

➤ **To edit the Historical Test record**

1. Tap **Data Manager** on the MaxiIM Job Menu.
2. Tap **Vehicle History**.
3. Select the specific vehicle history record thumbnail on the main section. The Historical Test screen will display.
4. Tap **Edit** (a pen icon) to start editing.
5. Tap each item to input information.

 **NOTE**

The vehicle VIN, license number, and customer account information are correlated by default. Vehicle records will automatically be correlated using this vehicle and customer identification.

6. Tap **Add to customer** to correlate the historical test record sheet to an existing customer account, or add a new associated account to be correlated with the vehicle record.
7. Tap **Done** to save the updated record, or tap **Cancel** to exit without saving.

Workshop Information

The Workshop Information screen allows you to enter, edit, and save thee detailed workshop information, such as shop name, address, phone number, and other remarks, which, when printing vehicle diagnostics reports and other associated test file, will display as the header of the printed documents.

Figure 11-3 Workshop Information Screen

- **To edit the Workshop Information sheet**
 1. Tap the **Data Manager** application on the MaxiIM Job Menu.
 2. Tap **Workshop Information**.
 3. Tap on each field to fill in the appropriate information.
 4. Tap **Back** icon to save the updated workshop information record.

Customer

The Customer function allows you to create and edit customer accounts. It helps you to save and organize all customer information accounts that are correlated with the associated vehicle history records.

- **To create a customer account**
 1. Tap the **Data Manager** application on the MaxiIM Job Menu.
 2. Tap **Customer**.
 3. Tap the **Add a customer** button. An empty information form displays. Tap each field to fill in the appropriate information.

NOTE

The items that must be filled are indicated as required fields.

4. Some customers may have more than one vehicle for service; you can always add new vehicle information to the account. Tap **Add new vehicle information**, and then fill in the vehicle information. Tap the  button to delete the information.
5. Tap **Complete** to save the account, or tap **Cancel** to exit without saving.

➤ **To edit a customer account**

1. Tap **Data Manager** on the MaxilM Job Menu.
2. Tap **Customer**.
3. Select a customer account by tapping the corresponding name card. A Customer Information record displays.
4. Tap **Edit** on the top toolbar to start editing.
5. Tap on the field to edit or amend information, and enter updated information.
6. Tap **Complete** to save the updated information, or tap **Cancel** to exit without saving.

➤ **To delete a customer account**

1. Tap **Data Manager** on the MaxilM Job Menu.
2. Tap **Customer**.
3. There are two ways to delete:
 - >>> Select a customer account by tapping the corresponding name card. A Customer Information record displays. Tap **Edit** on the top toolbar to start editing. Tap **Delete** on the top of the screen. A message displays.
 - >>> Tap **Delete** (garbage icon) on the right of the screen. A message displays.
4. Tap **OK** to conform the command, and the account is deleted. Tap **Cancel** to cancel the request.

Image





The Image section contains all captured screenshot images.



Figure 11-4 Image Screen

1. **Toolbar Buttons** — used to edit, print and delete the image files. See the following table for detailed information.
2. **Main Section** — displays the stored images.

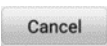
Table 11-1 Toolbar Buttons in Image

Button	Name	Description
	Back	Returns to the previous screen.
	Search	Displays the Search column.
	Edit	Tapping this button shows the editing toolbar to select, delete, print, or email the image(s).
	Cancel	Tapping this button close the editing toolbar or cancels file search.
	Print	Prints the selected image.
	Delete	Deletes the selected image.

Button	Name	Description
	Email	Sends the selected image via an email.

➤ **To edit/delete image information**

1. Select **Data Manager** Application on the MaxiIM Job Menu.
2. Select **Image** to access the image database.
3. Tap the **Edit** button on the top-right corner of the screen. The editing screen displays.
4. Select the image(s) you want to edit.
5. Tap **Delete** to delete the selected images or delete all images. Tap **Print** to print the selected image(s) or send the selected image(s) to an email by selecting **Email**.

 **NOTE**

To realize the wireless data printing function, you need to install the printer driver program.

Report

This section stores and displays all diagnostic reports. The reports stored in the report will be uploaded automatically when you set **ON** to the Report upload to Cloud on **Scan Report**. Tap one of the reports to view it or share it to cloud. Select **View local reports** to open it. Tap **Report cloud sharing** to share.

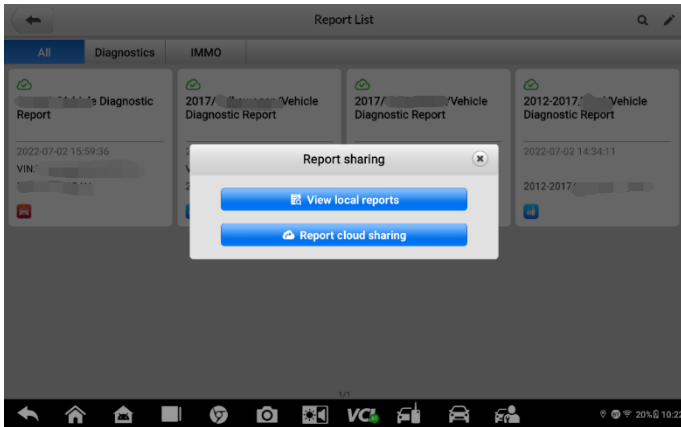

Figure 11-5 Report Screen

➤ **To share a report**

1. Tap the **Data Manager** application on the MaxiIM Job Menu.
2. Tap **Report** to access the “Report List” screen.
3. Tap a report record to display the “Record Sharing” dialog box.
4. Tap **Report Cloud Sharing**.
5. Scan the QR code or tap **Send Email** or **Send SMS** to share the report.

PDF Files

The PDF section stores and displays all PDF files of saved data. After entering the PDF database, select a PDF file to view the stored information.

This section uses the standard Adobe Reader application for file viewing and editing, please refer to the associated Adobe Reader manual for more detailed instructions.

Review Data

The Review Data section allows you to play back the recorded data frames of live data streams.

On the Review Data main screen, select a record file to play back.

Data Logging

The Data Logging section allows you to launch Support platform directly to view all records of all sent or unsent (saved) data loggings on the diagnostics system.

Apps Uninstall

This section allows you to manage the firmware applications installed on the MaxiM Diagnostics System. Selecting this section opens a managing screen, on which you can check all the available vehicle diagnostic applications.

Select the vehicle firmware you want to delete by tapping on the car brand icon, the selected item will display a blue tick at the bottom-right corner. Tap the **Delete** button on the top bar to delete the firmware from the system database.

Autel

12. Support

This application launches the Support platform which synchronizes Autel's on-line service base station with the tablet. In order to synchronize the device to your on-line account, you need to register the product through the Internet when you use it for the first time. The Support application is connected to Autel's service channel and on-line communities which provides the quickest way for problem solutions, allowing you to submit complaints or sent help requests to obtain direct services and supports.

The operations of these functions are mainly manipulated by the toolbar buttons, which are listed and described in the table below:

Product Registration

In order to get access to the Support platform and obtain update and other services from Autel, you are required to register the MaxiM Device the first time you use it. There are two ways for registration.

Option One:

➤ To register and link the MaxiM device

1. Visit the website: <http://pro.autel.com>.
2. If you have an Autel account, log in and skip to Step 7.
3. If you are a new member to Autel, click **Register** to create your Autel ID.
4. Enter your personal information. Fields marked with an asterisk (*) are mandatory.
5. After all the mandatory information is entered, read the **Autel User Service Agreement** and **Autel Privacy Policy**, then check the box to accept the terms and click **Register**.
6. Once your account is successfully registered, you will be redirected to the Product Registration screen. If not, click the button on the screen.
7. Your product serial number and password are required to enter. To find your serial number and password on the tablet: go to **Settings**>**About**.
8. Enter your tablet's serial number and password.
9. Enter the CAPTCHA code and click **Submit** to complete your product registration.

Option Two:

➤ To register and link the MaxilM Device

1. Tap **Autel User Center** on the MaxilM Job Menu.
2. If you have an Autel account, input your email or mobile number and password to log in or log in with verification code.
3. If you are a new member to Autel, click **Register** to create your Autel ID.
4. Enter your personal information. Fields marked with an asterisk (*) are mandatory.
5. Read the **Autel User Service Agreement** and **Autel Privacy Policy**, then check the box to accept the terms.
6. After all the mandatory information is entered, click **Register**.
7. Once your account is successfully registered, your account will be logged in automatically.
8. Tap **Device Management** to link your device.
9. Tap **Link Device** on the upper-right corner of the screen.
10. The serial number and password of the device will be shown on the screen. Tap **Link** to complete the operation.

Support Screen Layout

The main section of the Support screen is divided into two sections. The narrow column on the left is the main menu; selecting one subject from the main menu displays the corresponding function interface on the right.

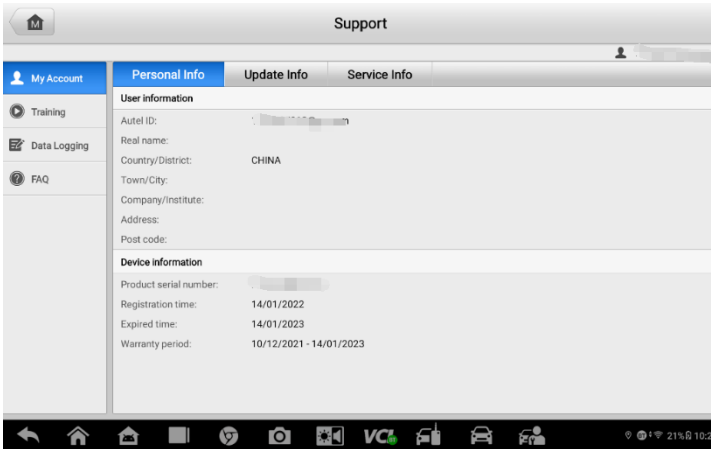

Figure 12-1 Support Screen

My Account

The My Account screen displays the comprehensive information of the user and the product, which is synchronized with the on-line registered account, including Personal Info, Update Info, and Service Info.

Personal Info

The user information and Device information columns are both included on the Personal Info tab.

- User information — displays detailed information of your registered on-line Autel account, such as your Autel ID, Real name, Country/District, Town/City, Company/Institute, Address, and Post code.
- Device information — displays the registered product information, including the Product serial number, Registration time, Expired time, and Warranty period.

Update Info

The Update Info tab displays a detailed record list of the product's software update history, including the product serial number, software version or name, and the update time.

Service Info

The Service Info tab displays a detailed record list of the device's service history information. Every time the device has been sent back to Autel for repair, the device's serial number and the detailed repair information, including Service date, Type of faults, and Repair content, will be recorded and updated to the associated online product account, which will be synchronized to the Service Info tab.

Training

The Training screen provides quick links to Autel's online video accounts. Select a video channel by the language to see all the available online tutorial videos from Autel for various technical supports, such as product usage techniques and vehicle diagnostics practice, etc., may be available for your interests.

Data Logging

The Data Logging screen keeps records of all Feedback (submitted), No feedback (saved) or History (up to the latest 20 test records) data loggings on the diagnostic system. The support personnel receive and process the submitted reports through the Support platform, and send back problem solutions within 48 hours to the corresponding Data Logging session, on which you are also allowed to have a direct conversation with the support personnel.

➤ To make a reply in a Data Logging session

1. Tap **Feedback** to view a list of submitted data loggings.
2. Select a specific item to view the latest update of the processing progress.
3. Tap the text field at the bottom of the screen, and enter the texts. Or tap the **Audio** button to record a voice message, or the **Camera** button to take a picture.
4. Tap **Send** to deliver your message to the technical center.

FAQ

The FAQ tab provides you comprehensive and abundant references for all kinds of questions frequently asked and answered about the use of Autel's online member account, and shopping and payment procedures.

- Account — displays questions and answers about the use of Autel's online user account.
- Shopping — displays questions and answers about online product purchase.
- Payment — displays questions and answers about payment methods or procedures.

13. VCI Manager

This application pairs the tablet with the MaxiFlash, checks the communication status and update the VCI software.

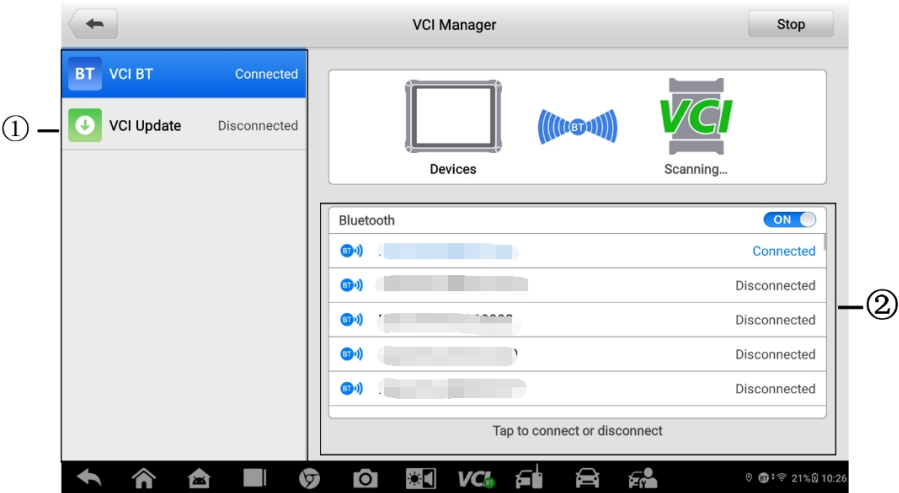

Figure 13-1 VCI Manager Screen

1. Connection Mode — there are two connection modes available for selection. The connection state is displayed alongside.
 - VCI BT — when paired to a VCI via Bluetooth, the connection state displays as **Connected**; otherwise it displays as **Disconnected**. See [VCI Connection](#) for more details.
 - VCI Update — updates VCI software via internet through the MaxiIM tablet networking using USB connection.
 - To update the VCI software
 1. Power on the tablet.
 2. Connect the VCI device to the tablet via USB or BT.
 3. Tap **VCI Manager** on the MaxiIM Job Menu.
 4. Select **VCI Update** on the connection mode list.
 5. The current version and the latest version of the VCI software will display. Tap **Update Now** to update the VCI software.
2. BT Settings — displays the types and product serial numbers for all the devices available for pairing. Tap a required device to start pairing. The BT status icon displayed to the left of the device name indicates the received signal strength.

14. Quick Link

The Quick Link application provides you with convenient access to Autel's official website and many other well-known sites in automotive service, which offers you abundant information and resources, such as technical help, knowledge base, forums, training, and expertise consultations.

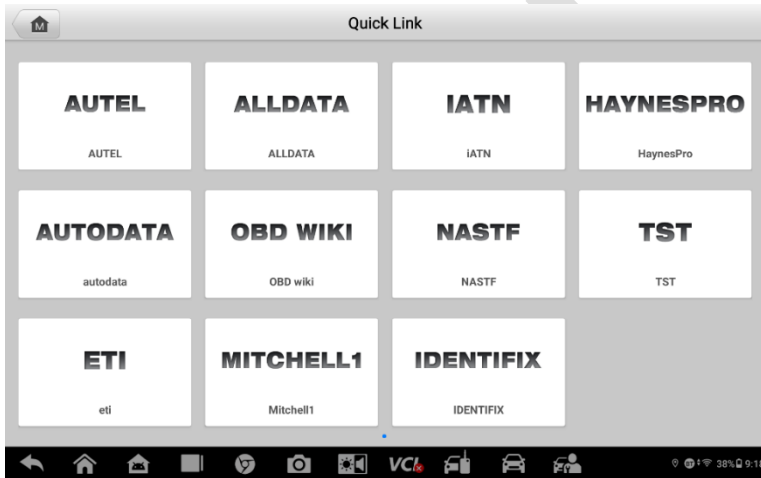

Figure 14-1 Quick Link Screen

➤ To access a quick link

1. Tap **Quick Link** on the MaxiIM Job Menu. The **Quick Link** screen displays.
2. Select a website thumbnail on the main section. The browser is launched and the selected website is opened.
3. Now start exploring the website.

15. User Feedback

The User Feedback application allows you to submit questions related to this product.

➤ **To send new user feedback**

1. Tap **User Feedback** on the MaxiIM Job Menu. The device information is automatically synchronized.
2. Set Telephone/Email, Feedback type, Theme, and Problem description. You can also attach voice recordings, photos, videos, images or PDF files to the form. To help us resolve the issue more efficiently, we recommend you complete the form with as much information as possible.
3. Tap **Submit** to send the completed form to Autel's online service center. The submitted feedback will be carefully read and handled by our service personnel.

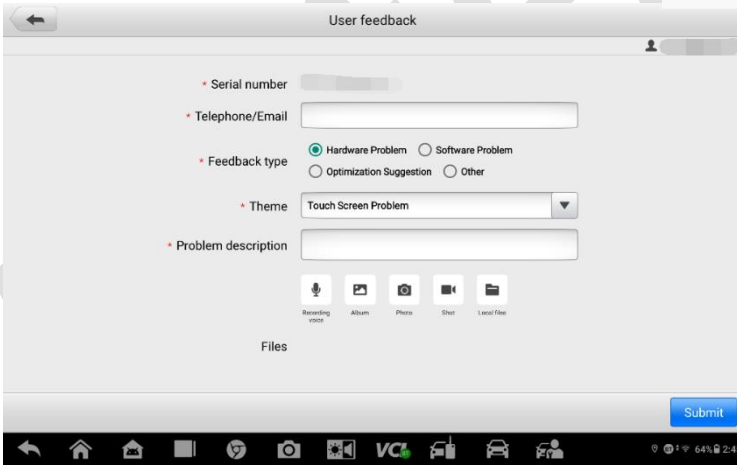

Figure 15-1 User Feedback Screen

16. OEM Authorization

The OEM Authorization application allows to unlock the gateway ECU (CGW) for some vehicles to perform advanced diagnostics tests.

NOTE

Make sure the tablet is connected to a stable network before launching the OEM Authorization application.

➤ To unlock the gateway ECU (CGW)

1. Connect the MaxiIM tablet to the vehicle through the MaxiFlash. See [Establish Vehicle Communication](#) for details.
2. Tap **Diagnostics** on the MaxiIM Job Menu.
3. Tap **Renault**, select the vehicle type and tap **OK** to confirm the vehicle information.
4. Tap **Unlock** on the Information screen.
5. On the Purchase, tap **OK**. Select the purchase method and pay to unlock the gateway. On the Purchase Successfully screen, tap **OK**.
6. Exit the Diagnostics application. Tap **OEM Authorization** on the MaxiIM Job Menu. On the OEM Authorization screen, tap **Renew**. The Unlocking Information screen appears, on which you can view the remaining service sessions.

17. MaxiViewer

The MaxiViewer application allows you to search the functions supported by our tools and the version information. There are two ways of searching, either by searching the product and the vehicle or searching the functions.

➤ **To search by product and vehicle**

1. Tap **MaxiViewer** on the MaxiIM Job Menu. The Function Viewer screen displays.
2. Select a product from the product type drop-down list.
3. Select vehicle brand, model, and year.

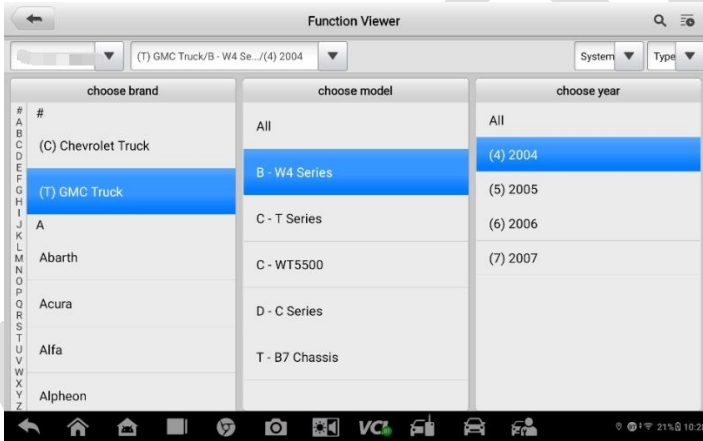

Figure 17-1 Function Viewer 1

- All functions supported by the selected product for the desired vehicle are displayed with vehicle's system, type, function, sub function, and version.

Year	System	Type	Function	Sub-function	Version
(4) 2004	Chassis	Medium duty truck	Live data	/	Above GM_V17.50
(4) 2004	Chassis	Medium duty truck	Trouble codes	/	Above GM_V17.50
(4) 2004	Chassis	Medium duty truck	Active test	/	Above GM_V17.50
(4) 2004	Powertrain	Medium duty truck	ECU information	/	Above GM_V17.50
(4) 2004	Powertrain	Medium duty truck	Live data	/	Above GM_V17.50
(4) 2004	Powertrain	Medium duty truck	Trouble codes	/	Above GM_V17.50
(4) 2004	Powertrain	Medium duty truck	Active test	/	Above GM_V17.50

Figure 17-2 Function Viewer 2

➤ **To search by functions**

- Tap **MaxiViewer** on the MaxiIM Job Menu. The **Function Viewer** screen shows.
- Select a product from the **Product Type** drop-down list.
- Tap the **Search** icon. Enter the desired function in the search box. The screen will display all vehicles that support this function, along with information such as the vehicles' year, system, capacity, type, function, sub-function, and version.

NOTE

Fuzzy search is supported.

18. MaxiVideo

The MaxiVideo application configures the MaxiIM Diagnostics Device to operate as a digital video scope by simply connecting the tablet to a MaxiVideo Camera. This function allows you to examine difficult-to-reach areas normally hidden from sight, with the ability to record digital still images and videos, which offers you an economical solution to inspect machinery, facilities, and infrastructure in a safe and quick way. The MaxiVideo Camera and its fittings are the additional accessories for the user to purchase separately.

Refer to the Quick Reference Guide of MaxiVideo for detailed operational instructions.

19. MaxiScope

The MaxiScope application configures the MaxilIM Device to operate as an automotive oscilloscope when working in combination with the MaxiScope module. This function provides all the features needed for performing electrical and electronic circuit tests as well as monitoring signal activities on any modern vehicles, which shows you what is really going on with a vehicle's electrical system.

Safety Information

Follow these instructions to reduce the risk of injury from electric shock and prevent equipment damage.

A. Maximum input ranges

Observe all terminal ratings and warnings marked on the product.

DANGER

- To prevent electric shock, operate within the safe input range for the scope.
- To prevent electric shock, take all necessary safety precautions when working on equipment where voltages above the specified input range may be present. Contact with voltages outside of the specified measuring range presents a risk of electric shock.
- To prevent injury or death, the oscilloscope must not be directly connected to the mains (line power). To measure mains voltages, use a differential isolating probe specifically rated for mains use.

WARNING

Operation outside of the safe input range is likely to cause permanent damage to the oscilloscope and other connected equipment.

B. Grounding

DANGER

- The scope's ground connection through the USB cable is for measurement purposes only. The oscilloscope does not have a protective safety ground.
- Do not connect the ground input (chassis) to any electrical power source. To prevent personal injury or death, use a voltmeter to check that there is no significant AC or DC voltage between the oscilloscope ground and the point to which you

intend to connect it.

⚠ WARNING

- Applying a voltage to the ground input is likely to cause permanent damage to the oscilloscope, the attached computer, and other equipment.
 - To prevent measurement errors caused by poor grounding, always use the high-quality USB cable supplied with the oscilloscope.
-

C. External connections

⚠ DANGER

To prevent injury or death, use only the power cord and adaptor supplied with the product.

D. Environment

⚠ DANGER

To prevent injury or death, do not use in wet or damp conditions, or around explosive gas or vapor.

⚠ WARNING

To prevent damage, always use and store your oscilloscope in appropriate environments. For detailed information on temperature and humidity specifications for both the storage and usage of the oscilloscope, see [Safety Information](#).

E. Product Maintenance

The product contains no user-serviceable parts. Repair, servicing and calibration require specialized test equipment and must only be performed by Autel Tech Support or an approved service provider.

⚠ DANGER

To prevent injury or death, do not use the product if it appears to be damaged in any way, and stop use immediately if you are concerned by any abnormal operations.

⚠ WARNING

- Do not tamper with or disassemble the oscilloscope, connectors or accessories. Internal damage will affect performance.
 - Do not block any of the instrument's air vents, as overheating will cause damage to the oscilloscope.
 - When cleaning the oscilloscope, use wet soft cloth with mild detergent in water. Do not allow water to enter the oscilloscope casing, as this will cause damage to the electronics inside.
-

Glossory

AC/DC Control

Each channel can be set to either AC coupling or DC coupling. With DC coupling, the voltage displayed on-screen is equal to the true voltage of the signal with respect to ground. With AC coupling, any DC component of the signal is filtered out, leaving only the variations in the signal for the AC component.

Aliasing

When the signal frequency gets higher than half the scope's maximum sampling rate and exceeds the limit, a distorted waveform appears. This distortion is called aliasing.

Analog Bandwidth

All oscilloscopes have an upper limit to the range of frequencies at which they can measure accurately. The analog bandwidth of an oscilloscope is defined as the frequency at which a displayed sine wave has half the power of the input sine wave (about 71% of the amplitude).

Block Mode

A sampling mode in which the computer prompts the oscilloscope to collect a block of data into its internal memory before stopping the oscilloscope and transferring the whole block into computer memory. This mode of operation is effective when the input signal being sampled is high frequency.

Buffer Size/Cache Size

This term indicates the size of the oscilloscope's buffer memory. The buffer memory is used by the oscilloscope to temporarily store data. This helps to compensate for the differences in data transfer rate from one device to another.

Sampling Rate

This term is used to define the number of samples per second captured by the oscilloscope. The faster the sampling rate of the scope, the more frequently it measures the signal voltage, and so the more detailed will be the trace that appears on the scope screen.

Streaming Mode

This term indicates a sampling mode in which the oscilloscope samples data and returns it to the computer in an unbroken stream. This mode of operation is effective when the

input signal being sampled is at low frequency.

Time Base

The time base controls the time interval across the scope display.

Voltage Range

The voltage range is the range between the maximum and minimum voltages that can be accurately captured by the oscilloscope.

Sinusoidal Waveform

This term describes the waveform characteristics typically found in circuits with large inductance and capacitance, and often referred to as an AC signal. The waveform alternates either side of 0 volts or may rise and fall creating a regular sinusoidal shape:

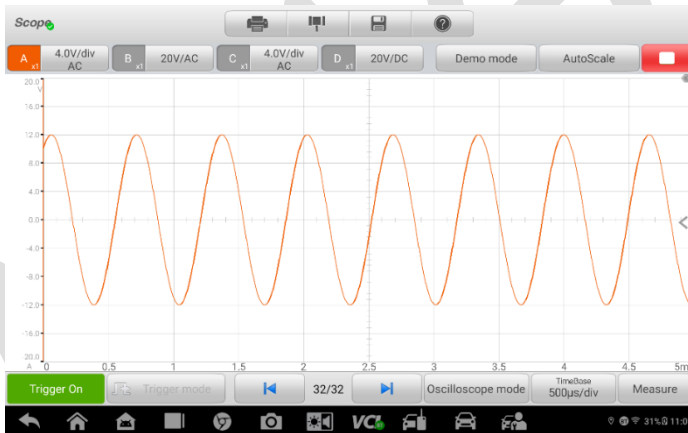

Figure 19-1 Sinusoidal Waveform Screen

Amplitude

This term indicates the maximum voltage generated from the zero volts line of the oscilloscope.

Frequency

This term describes the number of signal occurrences per second. Frequency is measured in Hz (hertz).

Square Waveform

This term describes the waveform characteristics normally generated by signals switching between clearly defined voltage levels, such as a Hal effect sensor signal may create by switching a voltage to ground. A typical digital square waveform is shown below:

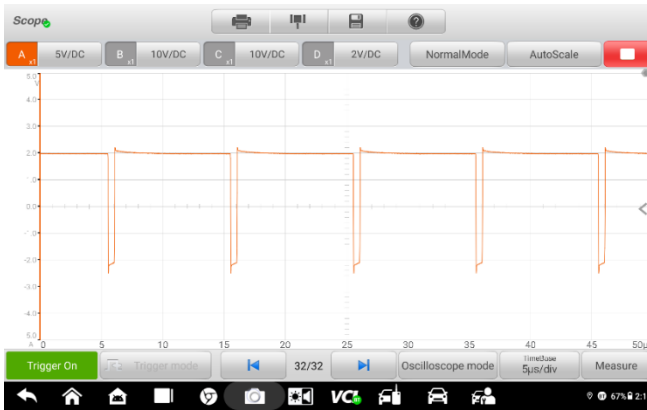

Figure 19-2 Square Waveform Screen

Peak to peak voltage

This term indicates the difference in voltage between the minimum and maximum voltages occurring in the waveform.

MaxiScope Module

The MaxiScope Automotive Oscilloscope tool kit is optional and available for purchase along with the MaxiSys package. There are 2 versions (basic and advanced versions) available.

The MaxiScope tool kit comes standard with:

- MaxiScope Module
- USB Cable
- Other probe accessories

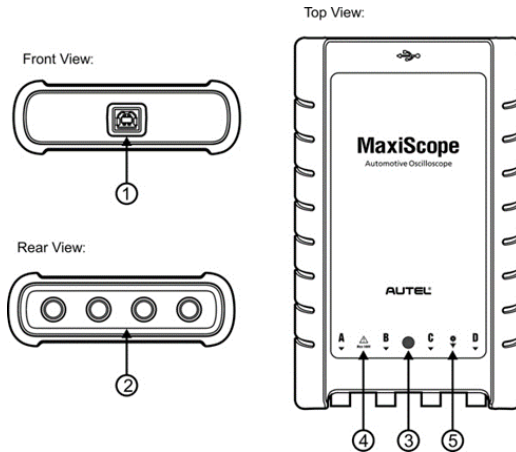

Figure 19-3 MaxiScope Module

1. **USB Port**
2. **Input Channel A/B/C/D**
3. **LED Indicator Light** — lights up when powered on, blinks when communicating, and shimmers when error occurs
4. **Warning Triangle** — indicates potential safety hazard that exists on the indicated connections, and appropriate precautions should be taken. Make sure you read through the [Safety Information](#) before use.
5. **Equipotential Symbol** — indicates the outer shells of the indicated BNC connectors are all at the same potential. Therefore, necessary precautions should be taken to avoid applying a potential through the return connections of the indicated BNC terminals, as this may result in a large current flow, causing damage to the product and the connected equipment.

Power Source

The MaxiScope MP408 Scope Module is powered directly by the USB port of the connected PC, no batteries or power leads are required, making it suitable for both workshop-based and mobile automotive diagnostics.

Technical Specifications

Table 19-1 *Technical Specifications*

Items	Description
Vertical resolution	12 bits
Channels	4
Bandwidth	20 MHz
Accuracy	Voltage: 1 %; Time: 50 ppm
Sensitivity	10 mV/div to 20 V/div
Input Ranges (full scale)	± 50 mV to ± 100 V in 11 ranges
Input Impedance	1 M Ω in parallel with 22pF
Input Type	Single-ended, BNC connector
Input Coupling	Software selectable AC/DC
Overload Protection	± 200 V on single input
Maximum Sampling Rate (Single Shot) 1 or 2 channels in use 3 or 4 channels in use	80 MS/s* 20 MS/s
Buffer Memory	32 M samples shared among active channels
Waveform Buffer	Up to 1000 waveforms
Timebase Ranges	100 ns/div to 1000 s/div
Advanced Features	Math channels, Measurements
Triggers	Description
Source	Any input channel
Basic Triggers	Auto, Normal, Single, None
Advanced Triggers	Rising edge, Falling edge
Environmental	Description
Operating Temperature Range	0 to 50 °C (32 to 122 °F) (15 to 40 °C (59 to 104 °F) for quoted accuracy)
Storage Temperature Range	-20 to 60 °C (-4 to 140 °F)
Storage Humidity Range	5 to 95 % RH, Non-condensing
Physical Characteristics	Description
Dimensions (L x W x H) (Protection rubber case included)	190 mm (7.48") x 115 mm (4.53") x 38 mm (1.5")

Items	Description
Weight	< 0.5 kg (1.10 lbs.)
General	Description
PC Interface	USB 2.0 – cable supplied
Power Requirements	Powered from USB port
Compliance	FCC (EMC), CE (EMC and LVD), RoHS
Warranty	1 year

NOTE

Reduced to 20 MS/s if channels A and B, or C and D are enabled.

Screen Layout and Operations

The MaxiScope application works as a signal processing program that displays the shape of electrical signals on-screen with a live graph showing voltage against time. The grid on the screen shows divisions of voltage and time to enable measurements to be made.

Units of voltage per division are shown down the side of the scope screen while units of time per division are shown along the bottom. The graph is referred to as a waveform and the scope repeatedly draws the trace across the screen from left to right.

Before performing the MaxiScope application, the MaxiScope Module must be connected to the tablet. Apply appropriate probe accessories supplied with the MaxiScope tool kit for use in various tests.

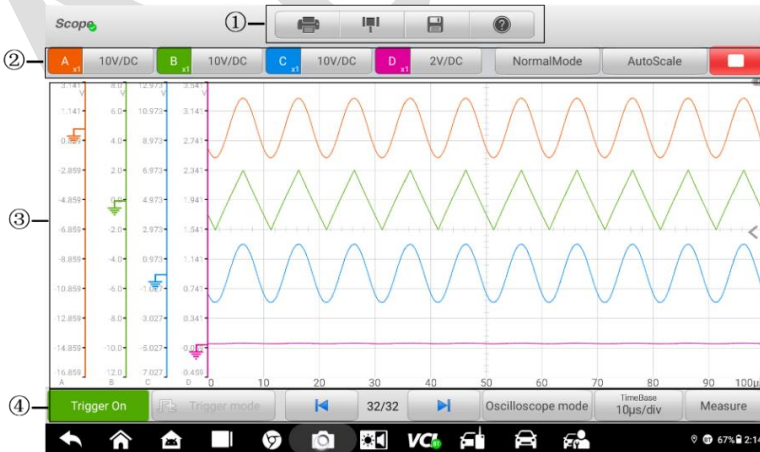





Figure 19-4 Oscilloscope Application Screen Layout

1. **Top Toolbar** — used for configurations of various settings and operations of the scope
2. **Function Buttons** on the upper part — used for configurations of channel activation, measurement scale and trigger settings
3. **Measurement Grid** — displays measurements of voltage against time
4. **Function Buttons** on the lower part — used for configurations of trigger, time base, and measurement parameter display settings.

Top Toolbar

The top toolbar contains various function buttons with options for operations and configurations of the MaxiScope, the operations of which are described in the table below:

Table 19-2 Toolbar Buttons

Button	Name	Descriptions
	Print	Saves and prints a copy of the displayed data.
	Tool	<p>Tapping this button opens a settings window with options to configure various measurement tools for reference and assessment of data analysis:</p> <ul style="list-style-type: none"> • Tap Select a Math Channel to select a math channel. • Tap Select a Probe to select a predefined probe. • Tap Cache Setting to set the cache.
	Save	<p>Tapping this button opens a submenu, on which 5 options will display, allowing you to save, record, and play back the waveform data.</p> <ul style="list-style-type: none"> • Tap Save current page to take a screenshot image. • Tap Record data to save the current waveform data. • Tap Save Ref to save a copy of an existing signal waveform as reference. • Tap Review data allows selecting and reviewing the previously stored waveform recordings.

Button	Name	Descriptions
		<ul style="list-style-type: none"> Tap Recall Ref to retrieve the saved reference waveforms. <p>All saved images are stored in the Data Manager application for later reviews. See Image.</p>
	Help	Provides instructions or tips for operations of various functions.

Math Channel

A math channel is a virtual channel generated by mathematical function of the input channel. It can be displayed in a scope in the same way as an input signal, and like an input signal, it has its own measure axis, scaling, and color. The MaxiScope module has a set of built-in math channels for the most important functions, including “A+B” (the sum of channels A and B) and “A-B” (the difference between channels A and B).

➤ To use a math channel:

1. Tap the **Tool** button in the Top Menu.
2. Tap the **Select a Math Channel** option on the left column.
3. Tap the desired option on the right column to enable the math channel in the channel list.
4. The Math Channel displays on the MaxiScope screen.

Probe

A probe is any transducer, measuring device or other accessory that you connect to an input channel of your MaxiScope module.

Reference Waveform

A Reference Waveform is a copy of an existing signal waveform saved as a reference. It can be retrieved to display as a comparative reference to examine a live signal. Up to 4 reference waveforms can be saved.

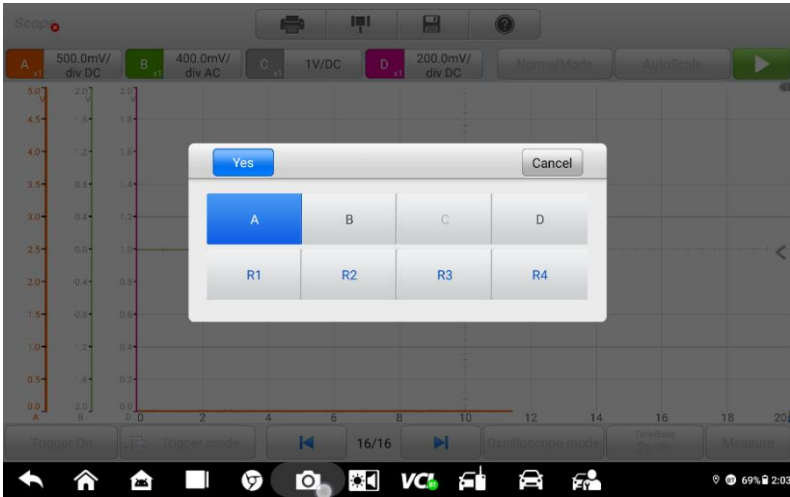

Figure 19-5 Ref. Waveform Save Window

- **To create a Reference Waveform:**
 1. Tap the **Tool** button in the Top Menu.
 2. Select **Save Ref.** in the dropdown menu.
 3. Select the channel, to which the desired waveform belongs.
 4. Name the reference waveform by selecting R1, R2, R3 or R4 in the pop-up window.
 5. Tap on the **Yes** icon to save, or **Cancel** icon to cancel.

Recall Reference

The saved reference waveforms can be retrieved by tapping Recall Ref in the dropdown menu of the Tool button.

- **To recall reference waveforms**
 1. Tap **Tool** button on the Top Menu.
 2. Select **Recall Ref** in the dropdown menu and a pop-up window will display. Available reference waveform items are highlighted in blue.

3. Select the desired reference waveform by ticking the check box alongside.
4. Tap **Yes** and the selected reference waveform will appear on the scope screen.

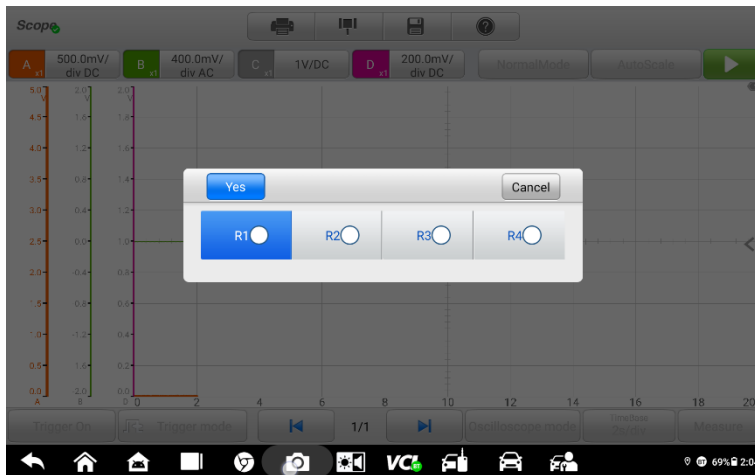

Figure 19-6 Recall Reference Waveform Window

Function Buttons

This group of buttons is used for configurations of channel activation, measurement scale, and trigger settings. The operations of which are described below:

- **Channel Control Buttons A/B/C/D** — tapping each button allows you to activate or deactivate the corresponding channel; long pressing the button opens a window, which allows you to select and configure appropriate probes for specific tests.

The Channel Control Buttons are displayed in different colors as follows:

- A. Red
- B. Green
- C. Blue
- D. Pink

- **AC/DC Coupling and Voltage Scale Buttons** — tapping this button opens a dropdown menu, on which you can select AC or DC measurements and adjust voltage measurement scales.

The **Auto voltage scale** option enables the scope to adjust the voltage scale automatically

to capture the signal.

- **AutoScale** — tapping this button enables automatic set-up of the voltage scale and time base for the signals received.
- **Start/Stop** — tapping this button turns on/off the scope.
- **Single** — tapping this button activates the Single trigger mode when the trigger is on. The Single trigger mode configures the trigger to occur once when the scope captures the first signal waveform by the preset trigger point.

Measurement Grid

The 2 control features — Voltage per division and Time per division — enable the users to adjust the scope settings to suit the particular test measurement.

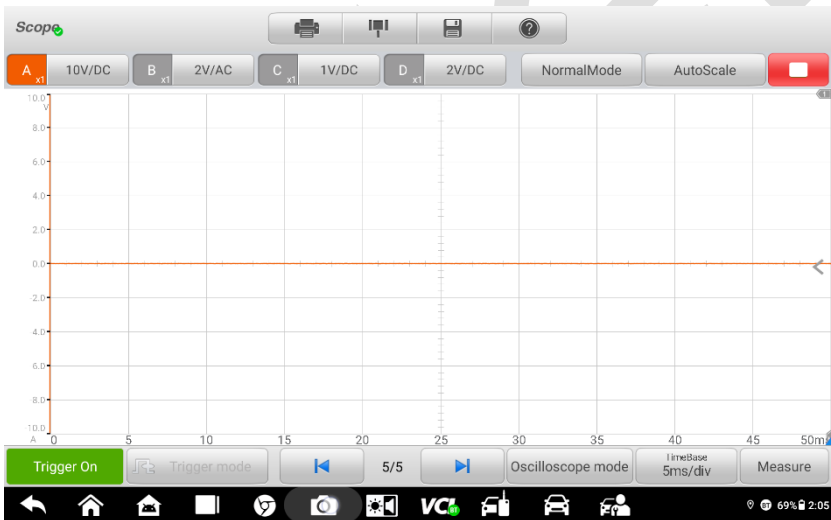

Figure 19-7 Measurement Grid

- **Voltage per division** — shown down the left side of the screen, referred to as the Y-axis.
- **Time per division** — shown along the bottom of the screen, referred to as the X-axis.

Multiple Scope Channels

The MaxiScope software features multiple channel display which enables more than one waveform to be displayed at the same time. It is useful for making comparisons among

different signals. The voltage per division for each channel is adjusted individually while the time base per division is the same for all channels.

➤ **To adjust the voltage scale**

1. Tap the specific Y-axis of the corresponding channel to enable scale adjustment. The selected Y-axis is highlighted with thicker dividing line.
2. Adjust the voltage scale of the selected channel with the typical two-finger zoom gestures.
3. The 0 volts is hinted with a pointer reference line. Slide the pointer line up and down to move and view different areas of the scale.
4. Tap once on the screen area outside of the Y-axis to finish the voltage scale adjustment.

➤ **To adjust the time base scale**

1. Unselect the Y-axis if it's activated.
2. Use two fingers to adjust the time base with the typical zoom gestures on the measurement grid area.

Measurement Rulers

The Measurement Rulers allow the voltage and time duration of a waveform to be measured precisely. There are 2 kinds of measurement rulers: the vertical **Time Ruler** and the horizontal **Voltage Ruler**.

Tap on the **Ruler Activator** on the bottom-right corner of the measurement grid and drag it across the screen to the desired position. A **Time Ruler** is generated.

The **Voltage Ruler** can be generated in the similar way by tapping the **Ruler Activator** on the top-left corner and dragging it downwards.

When **Measurement Rulers** are generated, a **Ruler Table** showing time and voltage values for the corresponding channels will be displayed. The **Delta** icon refers to the absolute difference between the values of the 2 rulers, which can be locked by tapping the **Lock** icon.



Figure 19-8 Measurement Rulers Display

Function Buttons

This group of buttons includes trigger setting buttons allowing you to set trigger source and trigger mode, a **Time base** button for adjustment, and a **Measurement** button with options for various measurement types.

- **Trigger On/Off** — taps to turn on/off the trigger. The button displays as **Trigger Off** when it is activated, and vice versa.

Once the trigger is activated, a voltage scale reference line and a time base reference line will be displayed on the measurement grid. The cross point of the 2 lines indicates the trigger point, allowing users to adjust its position by moving each of the 2 lines.

- **Trigger Source** — assigns the trigger to a specific channel
- **Trigger Slope** — sets trigger to occur by rising or falling voltage edges
- **Trigger Mode** — configures the trigger mode:
 - Normal Mode** — configures the trigger to occur every time when the captured signal waveform reaches the trigger point, so the scope starts to draw the waveform when the signal reaches the trigger point.
 - Auto Mode** — configures the trigger to occur every time when the scope captures

the signal waveforms by the preset trigger point. The scope continues to draw the waveforms even when the signal is not in the trigger point range.

- **Main Time Base** — allows users to select an appropriate time per division. The time per division (10 divisions) is displayed along the bottom of the screen. The time base adjustment affects all of the active scope channels at once.
- **Measure** — allows users to select various types of measurement parameters to be displayed at the right side of the screen for reference.

A maximum of 5 items are allowed to be selected each time.

➤ **To set a specific trigger point**

1. Tap the **Trigger On** button to activate the trigger.
2. Configures the specific trigger source, the trigger slope, and the trigger mode according to the test demand.
3. Tap and slide the voltage scale reference line up or down to the desired voltage point. The voltage info is displayed in a small reference box.
4. Tap and slide the time base reference line left or right to the desired point.
5. Tap **Start** button on the top-right side of the screen to activate the scope.

Troubleshooting

If the MaxiScope is not communicating with the tablet, you need to do the followings:

- Check if the MaxiScope is properly connected to the tablet through the supplied USB cable.
- If the MaxiScope is already connected to the tablet, but the communication between the devices has failed, tap the **Scope Icon** on the top-right side of the screen to reset the USB connection.

! IMPORTANT

All vehicle communications must be terminated before resetting the USB connection to avoid damage to the devices and the vehicle. The Internet connection may be aborted during USB reset.

- If the communication between the MaxiScope and the tablet still fails after USB reset, restart the tablet and reconnect the MaxiScope.

MaxiScope Firmware Update

The operating software of the MaxiScope is continuously being developed, and the update package can be downloaded free from the MaxiScope product webpage on Autel's website: <http://www.autel.com>.

Autel

20. Maintenance and Service

Maintenance Instructions

The following shows how to maintain your devices, together with precautions to take.

- Use a soft cloth and alcohol or a mild window cleaner to clean the touch screen of the tablet.
- Do not use any abrasive cleansers, detergent, or automotive chemicals to the tablet.
- Maintain the devices in dry conditions and keep them within normal operating temperatures.
- Dry your hands before using the tablet. The touch screen of the tablet may not work if the touch screen is moist, or if you tap the touch screen with wet hands.
- Do not store the devices in humid, dusty or dirty areas.
- Check the housing, wiring, and connectors for dirt and damage before and after each use.
- At the end of each work day, wipe the device housing, wiring, and connectors clean with a damp cloth.
- Do not attempt to disassemble your tablet or the VCI unit.
- Do not drop or cause severe impact to the devices.
- Use only authorized battery chargers and accessories. Any malfunction or damage caused by the use of unauthorized battery charger and accessories will void the limited product warranty.
- Ensure that the battery charger does not come in contact with conductive objects.
- Do not use the tablet beside microwave ovens, cordless phones and some medical or scientific instruments to prevent signal interference.

Troubleshooting Checklist

A. When the tablet does not work properly:

- Make sure the tablet has been registered online.
- Make sure the system software and diagnostic application software are properly updated.
- Make sure the tablet is connected to the Internet.
- Check all cables, connections, and indicators to see if the signal is being received.

B. When battery life is shorter than usual:

- This may happen when you are in an area with low signal strength. Turn off your device if it is not in use.

C. When you cannot turn on the tablet:

- Make sure the tablet is connected to a power source or the battery is charged.

D. When you are unable to charge the tablet:

- Your charger maybe out of order. Contact your nearest dealer.
- You may be attempting to use the device in an overly hot/cold temperature. Try changing the charging environment.
- Your device may have not been connected to the charger properly. Check the connector.

 **NOTE**

If your problems persist, please contact Autel's technical support personnel or your local selling agent.

About Battery Usage

Your tablet is powered by a built-in Lithium-ion Polymer battery. This means that, unlike other forms of battery technology, you can recharge your battery while some charge remains without reducing your tablet's autonomy due to the "battery memory effect" inherent in those technologies.

 **DANGER**

The built-in Lithium-ion Polymer battery is factory replaceable only; incorrect replacement or tampering with the battery pack may cause an explosion.

Do not use a damaged battery charger.

- Do not disassemble or open crush, bend or deform, puncture or shred.
- Do not modify or remanufacture, attempt to insert foreign objects into the battery, expose to fire, explosion or other hazard.
- Make sure to use the charger and USB cables only that come together in the package. If you use the other charger and USB cables, you might incur malfunction or failure of the device.
- Only use the charging device that has been qualified with device per the standard. Use of an unqualified battery or charger may present a risk of fire, explosion, leakage, or other hazard.
- Avoid dropping the tablet. If the tablet is dropped, especially on a hard surface, and the user suspects damage, take it to a service center for inspection.
- The closer you are to your network's base station, the longer your tablet usage time

because less battery power is consumed for the connection.

- The battery recharging time varies depending on the remaining battery capacity.
- Battery life inevitably shortens over time.
- Since over charging may shorten battery life, remove the tablet from its charger once it is fully charged. Unplug the charger, once charging is complete.
- Leaving the tablet in hot or cold places, especially inside a car in summer or winter, may reduce the capacity and life of the battery. Always keep the battery within normal temperatures.

Autitel

21. Compliance Information

FCC Compliance

FCC ID: WQ8-IM608PRO2121

This device complies with Part 15 of the FCC rules and Industry Canada's license-exempt RSSs. Operation is subject to the following two conditions:

1. This device may not cause harmful interference.
2. This device must accept any interference received, including interference that may cause undesired operation.

Cet appareil est conforme aux CNR exempts de licence d'Industrie Canada. Son fonctionnement est soumis aux deux conditions suivantes:

1. Ce dispositif ne peut causer des interférences; et
2. Ce dispositif doit accepter toute interférence, y compris les interférences qui peuvent causer un mauvais fonctionnement de l'appareil.

WARNING

Changes or modifications not expressly approved by the party responsible for compliance could void the user's authority to operate the equipment.

NOTE

This equipment has been tested and found to comply with the limits for a Class B digital device, pursuant to Part 15 of the FCC Rules. These limits are designed to provide reasonable protection against harmful interference in a residential installation.

This equipment generates uses and can radiate radio frequency energy and, if not installed and used in accordance with the instructions, may cause harmful interference to radio communications. However, there is no guarantee that interference will not occur in a particular installation. If this equipment does cause harmful interference to radio or television reception, which can be determined by turning the equipment off and on, the user is encouraged to try to correct the interference by one or more of the following measures:

- Reorient or relocate the receiving antenna.
- Increase the separation between the equipment and receiver.
- Connect the equipment into an outlet on a circuit different from that to which the receiver is connected.
- Consult the dealer or an experienced radio/TV technician for help.

Changes or modifications not expressly approved by the party responsible for compliance could void the user's authority to operate the equipment.

SAR

The radiated output power of this device is below the FCC radio frequency exposure limits. Nevertheless, the device should be used in such a manner that the potential for human contact is minimized during normal operation.

The exposure standard for wireless devices employs a unit of measurement known as the Specific Absorption Rate, or SAR. The SAR limit set by the FCC is 1.6 W/Kg. Tests for SAR are conducted using standard operating positions accepted by the FCC with the device transmitting at its highest certified power level in all tested frequency bands.

Although the SAR is determined at the highest certified power level, the actual SAR level of the device while operating can be well below the maximum value. This is because the device is designed to operate at multiple power levels so as to use only the power required to reach the network. To avoid the possibility of exceeding the FCC radio frequency exposure limits, human proximity to antenna should be minimized.

RF WARNING STATEMENT

The device has been evaluated to meet general RF exposure requirement. The device can be used in portable exposure condition without restriction.

The term "IC" before the radio certification number only signifies that IC technical specifications were met.

RoHS COMPLIANCE

This device is declared to be in compliance with the European RoHS Directive 2011/65/EU.

CE COMPLIANCE

This product is declared to conform to the essential requirements of the following Directives and carries the CE mark accordingly:

RED Directive 2014/53/EU

22. Warranty

Limited One Year Warranty

Autel Intelligent Technology Corp., Ltd. (the Company) warrants to the original retail purchaser of this MaxiIM Diagnostic Device, that should this product or any part thereof during normal consumer usage and conditions, be proven defective in material or workmanship that results in product failure within one (1) year period from the date of purchase, such defect(s) will be repaired, or replaced (with new or rebuilt parts) with Proof of Purchase, at the Company's option, without charge for parts or labor directly related to the defect(s).

NOTE

If the warranty period is inconsistent with local laws and regulations, please comply with the relevant local laws and regulations.

The Company shall not be liable for any incidental or consequential damages arising from the use, misuse, or mounting of the device. Some states do not allow limitation on how long an implied warranty lasts, so the above limitations may not apply to you.

This warranty does not apply to:

- a) Products subjected to abnormal use or conditions, accident, mishandling, neglect, unauthorized alteration, misuse, improper installation or repair or improper storage;
- b) Products whose mechanical serial number or electronic serial number has been removed, altered or defaced;
- c) Damage from exposure to excessive temperatures or extreme environmental conditions;
- d) Damage resulting from connection to, or use of any accessory or other product not approved or authorized by the Company;
- e) Defects in appearance, cosmetic, decorative or structural items such as framing and non-operative parts.
- f) Products damaged from external causes such as fire, dirt, sand, battery leakage, blown fuse, theft or improper usage of any electrical source.

IMPORTANT

All contents of the product may be deleted during the process of repair. You should create a back-up copy of any contents of your product before any repair services.
